



WINDOWS & DOORS

HIGHLIGHTS OF ARCHITECTURE

Internorm[®]
Windows – Doors



Make your dream
HOME A REALITY.

CONTENTS

DESIGN STYLES / INSPIRATION	4
WINDOWS & DOORS	8
uPVC & uPVC-Aluminium	
KF 520 + KF 510 <i>New</i>	10
KF 410 + KF 310	12
KV 440 + KV 350 (integrated blind)	14
KS 430 Lift & Slide Door	16
Timber-Aluminium	
HF 510 <i>New</i>	20
HF 410 + HV 450 (integrated blind)	22
HS 330 Lift & Slide Door	24
HX 300 Panorama	26
Windows & Doors - Overview	28
Renovations	30
Finishes & Accessories	
Perfect Combinations	32
Juliet Balcony	34
Sun & Insect Protection	36
Raffstore External Blinds	38
Blind / Shutter Colours	40
I-tec Innovations	42
Eclaz®	45
Window Security	46
Window Handles	48
Window Colours	50
ENTRANCE DOORS	52
Series.F	54
Series.V <i>New</i>	60
Series.P	64
Series.D	72
Series.G	78
Entrance Doors – Overview	84
Finishes & Accessories	
Entrance Door Handles	86
Entrance Door Colours	90
Ekey Fingerprint Scanner / Keypad	92
SIDE ENTRANCE DOORS	94
WARRANTIES & CERTIFICATION	96
ABOUT US	98





DESIGN STYLES

ARCHITECTURAL HIGHLIGHTS

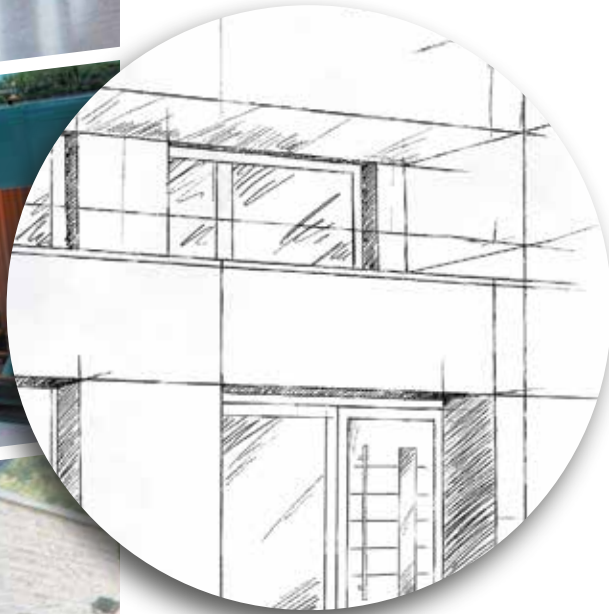

Windows and doors for your dream home

Architecture is as diverse as the people that live within it. The right windows and doors will add significant character to your home.

Internorm windows and doors allow you to create your individual living space by offering bespoke solutions tailored to your unique requirements. To find the ideal glazing for your project, you can choose from a wide range of colours, materials and accessories, Internorm products also come in four distinct design styles to enhance any architectural design: [studio](#), [home pure](#), [home soft](#) and [ambiente](#).

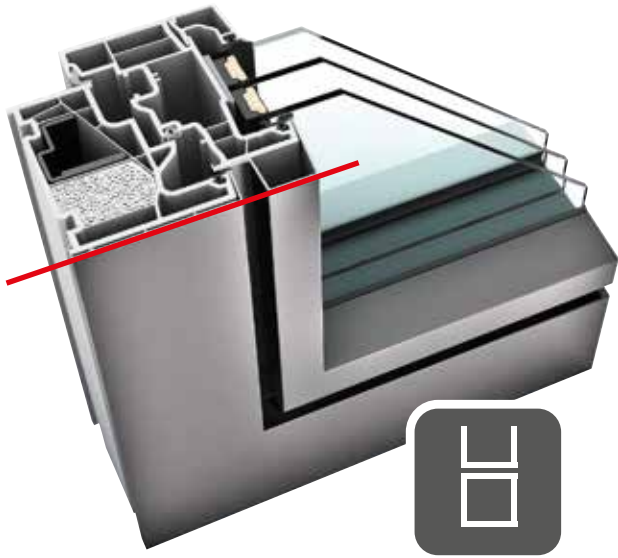

studio

The **studio** design style is characterised by clean lines and a minimalist design. The windows become a design feature in their own right, whilst enhancing exceptional architecture.

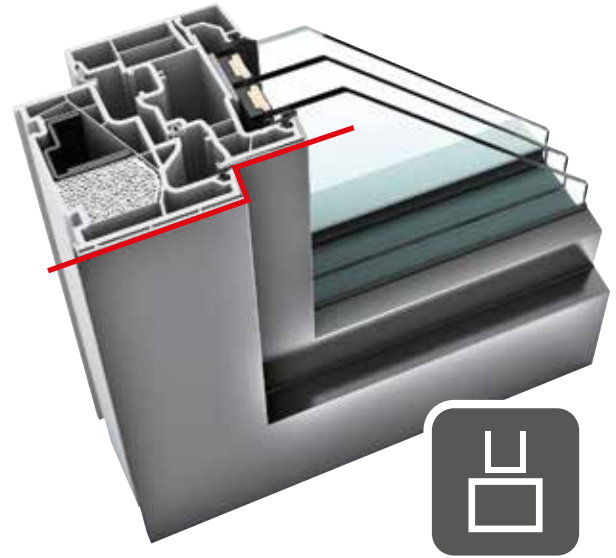

home pure

The modern **home pure** window with its square edge design perfectly blends into the unique architecture of contemporary buildings.



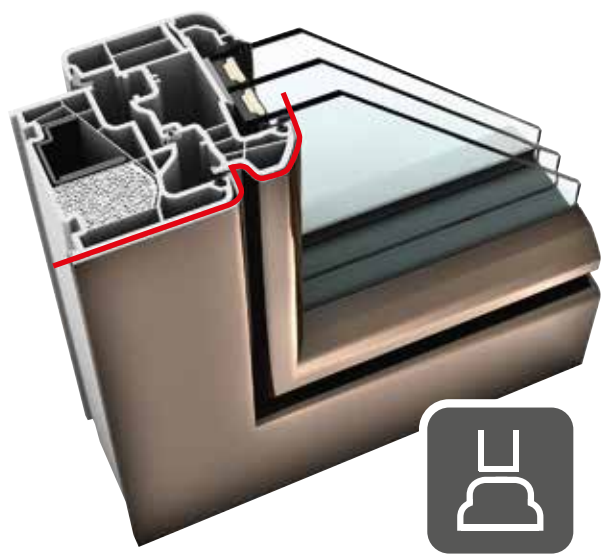
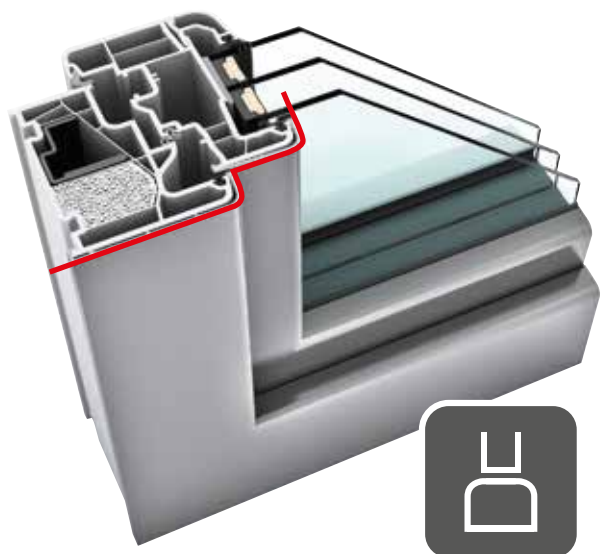

home soft

The elegant round edge design of a home soft window creates a timeless look that can be integrated effortlessly into any design and architecture.

ambiente

An ambiente window offers the perfect blend of traditional design and classic detailing. The round profiled edges add a special charm to any façade.



UPVC & UPVC-ALUMINIUM

CONTEMPORARY. CLEAN. VERSATILE.



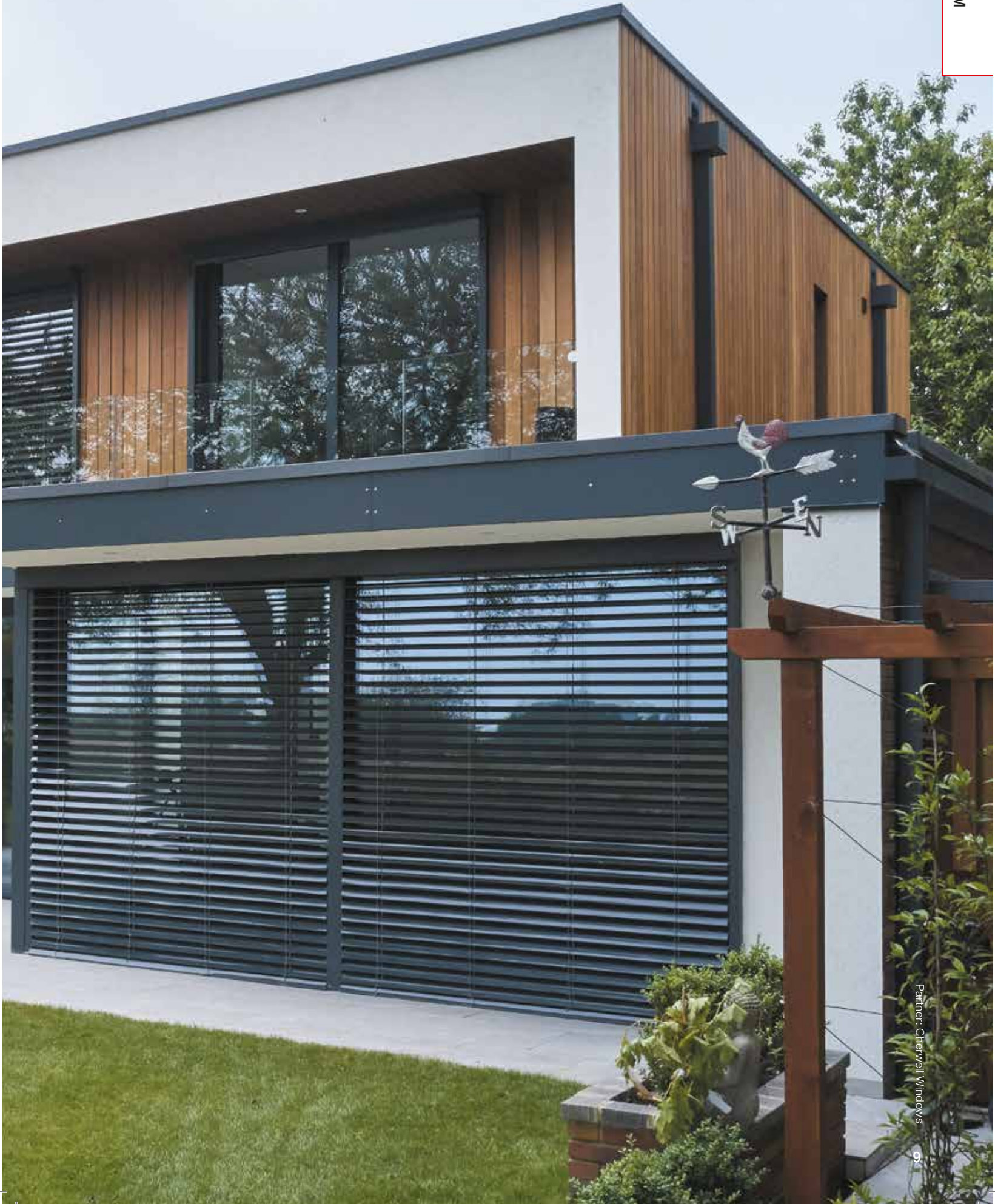

KF 520



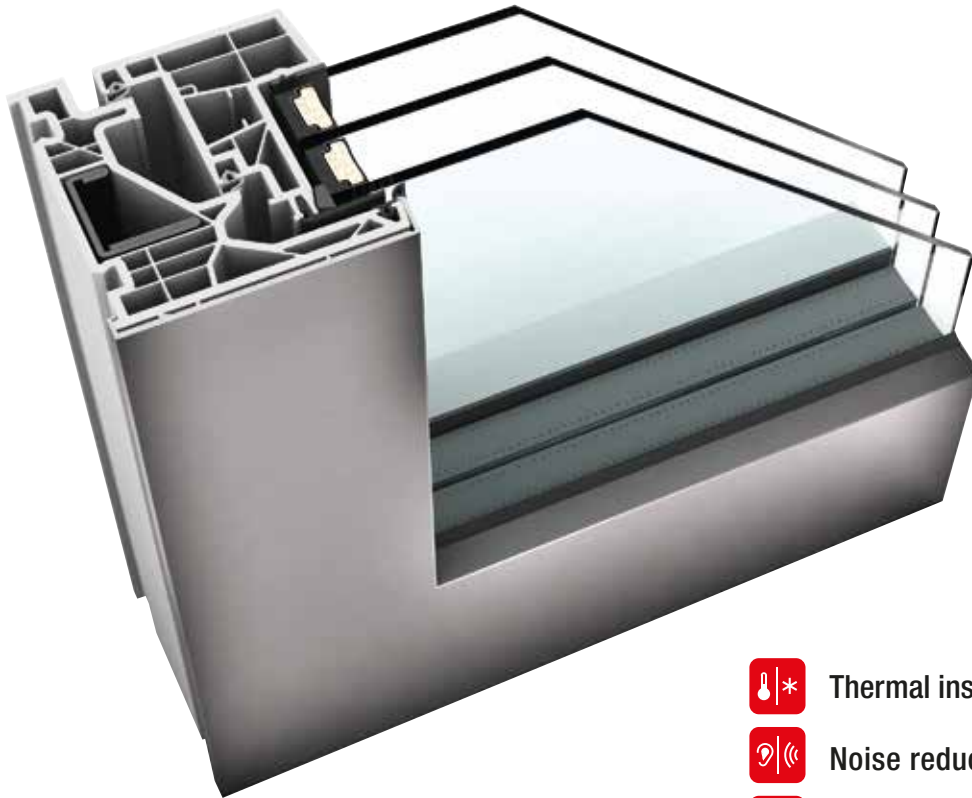

UPVC & UPVC-ALUMINIUM WINDOW



I-tec Glazing

I-tec Secure

studio

-  **Thermal insulation** U_w as low as 0.63 W/(m²K)
-  **Noise reduction** up to 46 dB
-  **Security** up to RC2, RC3
-  **Locking** fully integrated
-  **Construction depth** 90/93 mm



KF 520

Ideal for modern architecture, this innovative window system looks like fixed glazing from the outside but functions like a normal window. The revolutionary I-tec Secure can achieve the highest RC3 security rating, making it one of the most secure windows on the market.

KF 510



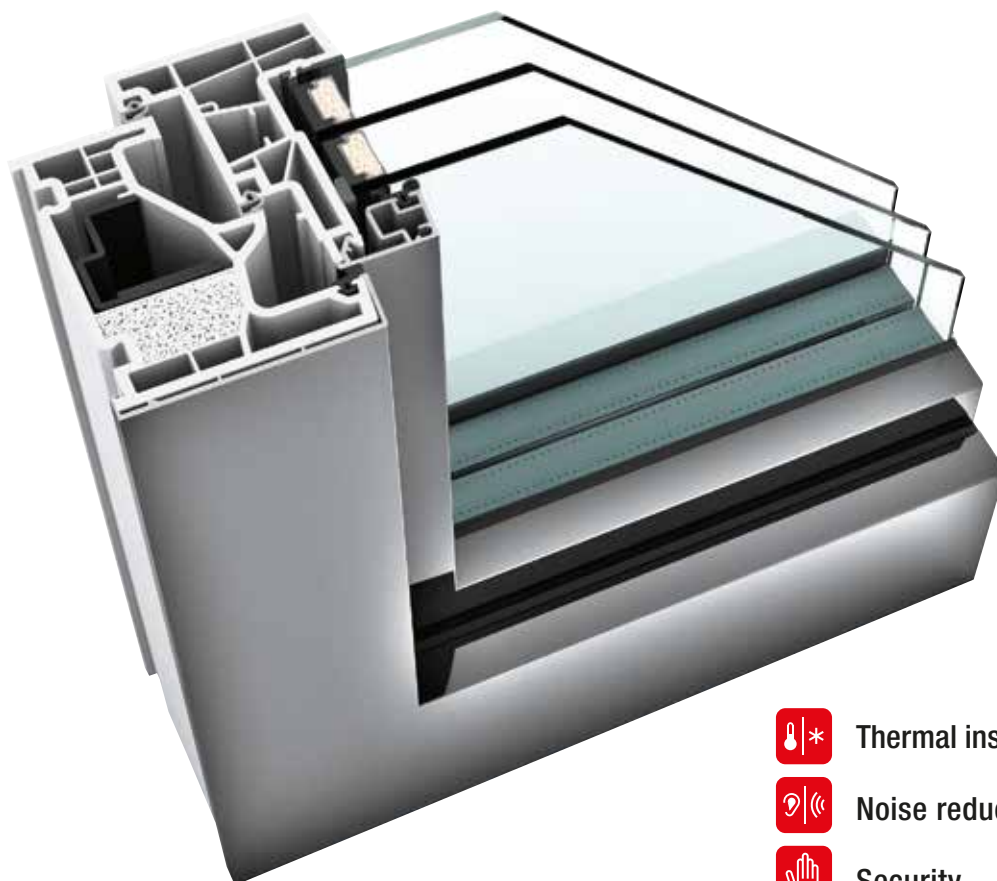

UPVC & UPVC-ALUMINIUM WINDOW



I-tec Glazing

I-tec Secure

home pure

-  **Thermal insulation** U_w as low as 0.63 W/(m²K)
-  **Noise reduction** up to 46 dB
-  **Security** RC2, RC3
-  **Locking** fully integrated
-  **Construction depth** 90/93 mm



KF 510

The particularly slim and modern frame of the KF 510 results in an even larger area of glazing to allow maximum light transmission and improved living. The fully integrated I-tec Secure system provides enhanced security thanks to the patented flap mechanism, which presses into all four sides of the frame when locking, making it virtually impossible to lever the window. The concealed hardware also makes it easy to clean, and combined with I-tec Insulation and I-tec Glazing, the new KF 510 offers the ideal window solution.

KF 410

UPVC & UPVC-ALUMINIUM WINDOW

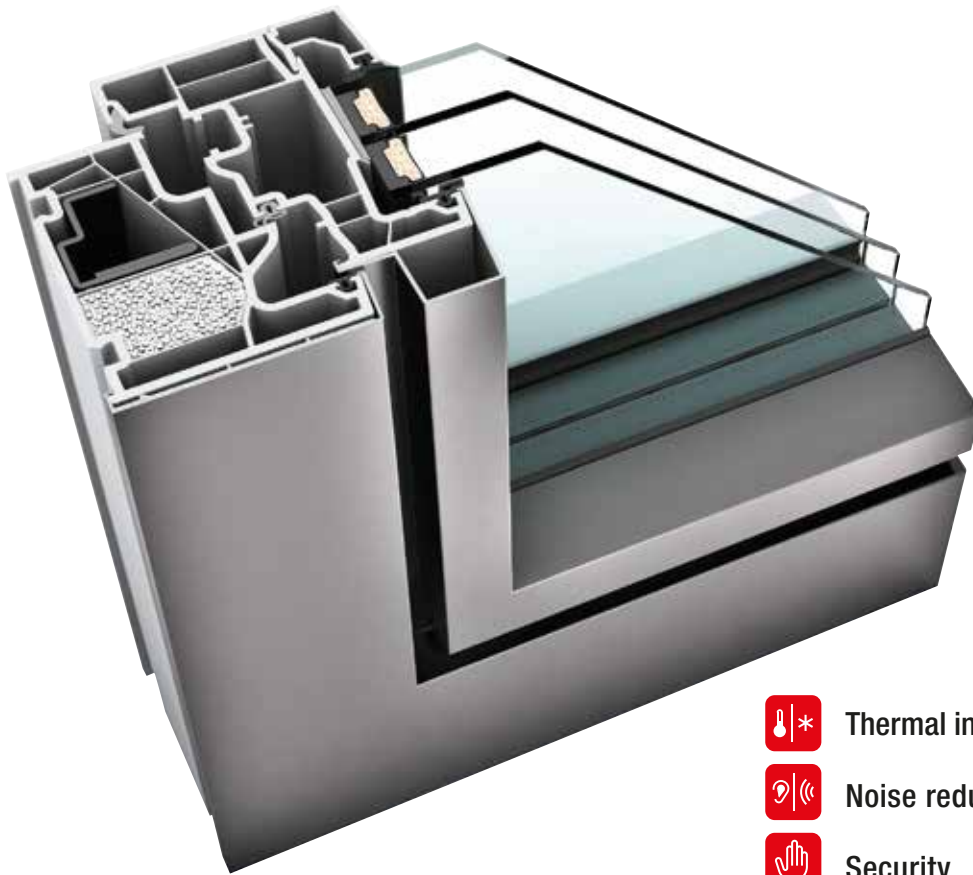

I-tec Glazing

I-tec Ventilation





I-tec Insulation

I-tec Connect

home pure

home soft

ambiente

-  **Thermal insulation** U_w as low as 0.62 W/(m²K)
-  **Noise reduction** up to 47 dB
-  **Security** up to RC1N, RC2
-  **Locking** concealed
-  **Construction depth** 90/93 mm

studio

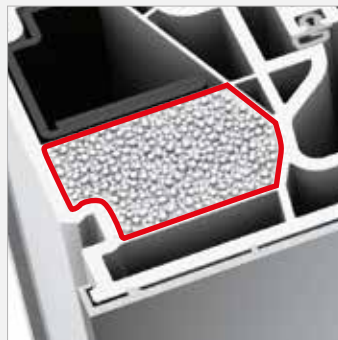
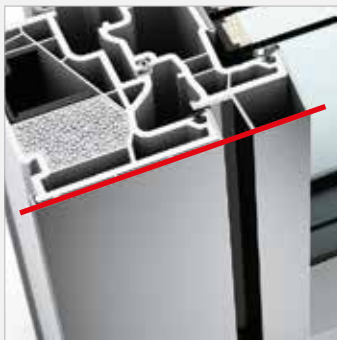

KF 410

The popular KF 410 is available in all four design styles and is therefore suitable for all types of architecture. I-tec Insulation, which includes insulating granulate that evenly fills the hollow chambers, provides considerable improvement in thermal performance. Also available with I-tec Ventilation to achieve ideal room temperature and living conditions.

KF 310

UPVC & UPVC-ALUMINIUM WINDOW







I-tec Glazing

home soft

ambiente

home pure

-  **Thermal insulation** U_w as low as 0.69 W/(m²K)
-  **Noise reduction** up to 45 dB
-  **Security** up to RC1N, RC2
-  **Locking** concealed
-  **Construction depth** 71/74 mm

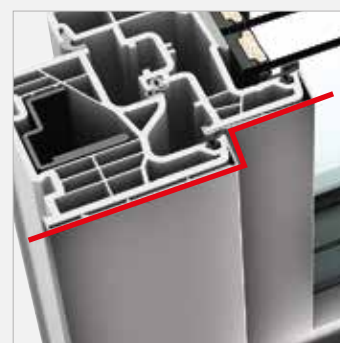
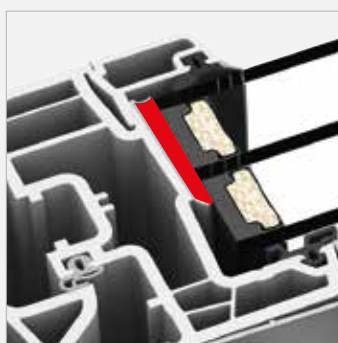
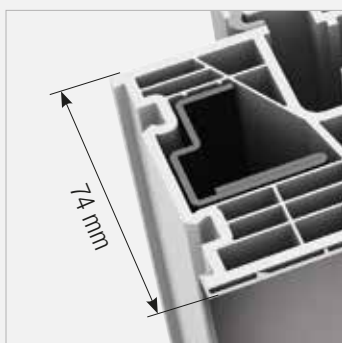

KF 310

This sleek window features our proven Internorm technology and provides exceptional thermal insulation and noise reduction performance. The KF 310 is also available as a balcony or patio door with an integrated Juliet balcony. Choose from a wide selection of aluminium colours, glazing and handle options.

KV 440

UPVC-ALUMINIUM WINDOW WITH INTEGRATED BLIND



I-tec Glazing

I-tec Shading

I-tec Ventilation





I-tec Insulation

I-tec Connect

home soft

ambiente

home pure

-  **Thermal insulation** U_w as low as 0.64 W/(m²K)
-  **Noise reduction** up to 45 dB
-  **Security** up to RC1N, RC2
-  **Locking** concealed
-  **Construction depth** 93 mm



KV 440

With the KV 440, the blind is fully integrated between accessible glass panes and is therefore protected from wind, rain and dirt, whilst still offering outstanding thermal performance with I-tec Insulation. Available with Venetian, Roman and Duette blinds in a selection of colours, the KV 440 offers privacy and sun protection, even for renovations or facades where roller shutters are not possible. The I-tec Shading option offers operation of the blinds via a photovoltaic module using solar energy, therefore not requiring an external power source.

KV 350

UPVC-ALUMINIUM WINDOW WITH INTEGRATED BLIND

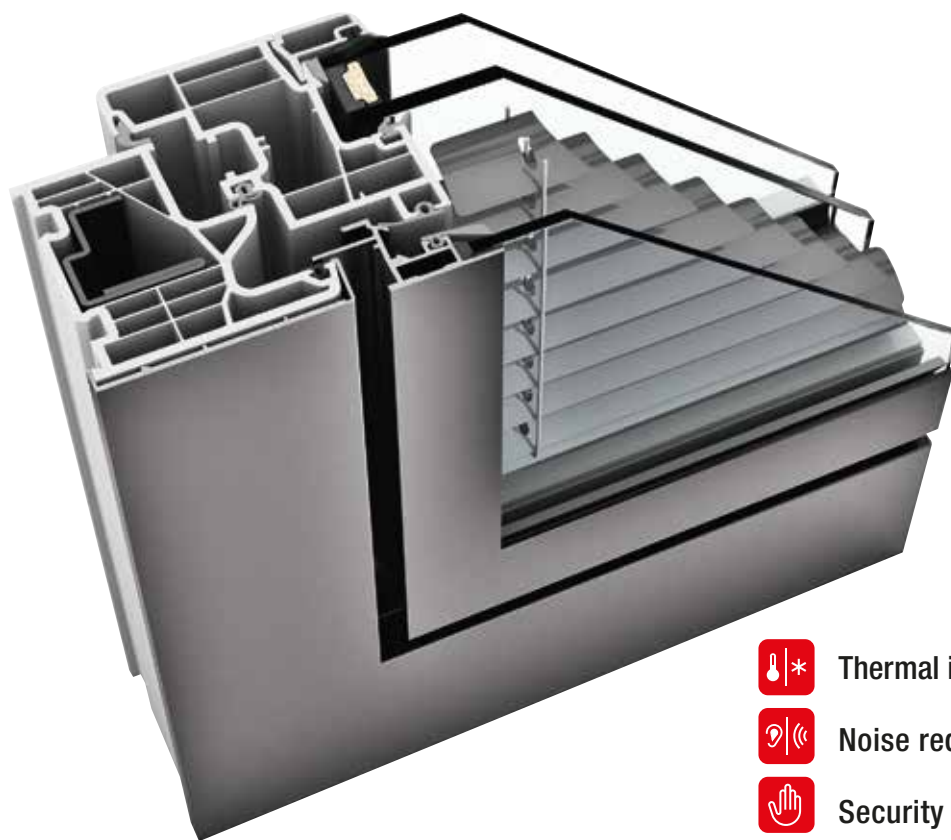





I-tec Glazing

I-tec Shading

I-tec Connect

ambiente

home pure

-  **Thermal insulation** U_w as low as 0.79 W/(m²K)
-  **Noise reduction** up to 44 dB
-  **Security** up to RC1N, RC2
-  **Locking** concealed
-  **Construction depth** 74 mm

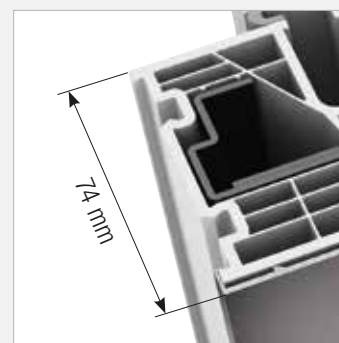
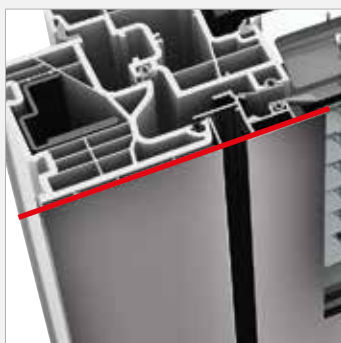

KV 350

This stylish and slim window, with a construction depth of only 74mm, benefits from integrated, accessible blinds between glass panes. Providing sun protection and privacy, and available with different blind options, the KV 350 can be perfectly matched with the KF 310 uPVC-Aluminum window. The 6-chamber frame profile, combined with the I-tec Glazing, offers improved thermal performance, noise reduction, as well as protection from damp entering the cavities.

KS 430

UPVC & UPVC-ALUMINIUM LIFT & SLIDE DOOR



NARROW

Narrow sliding frame and frameless elements with 3-sided rendering

COMFORTABLE

Low threshold without obstruction

SOFT

Soft handle closure as standard

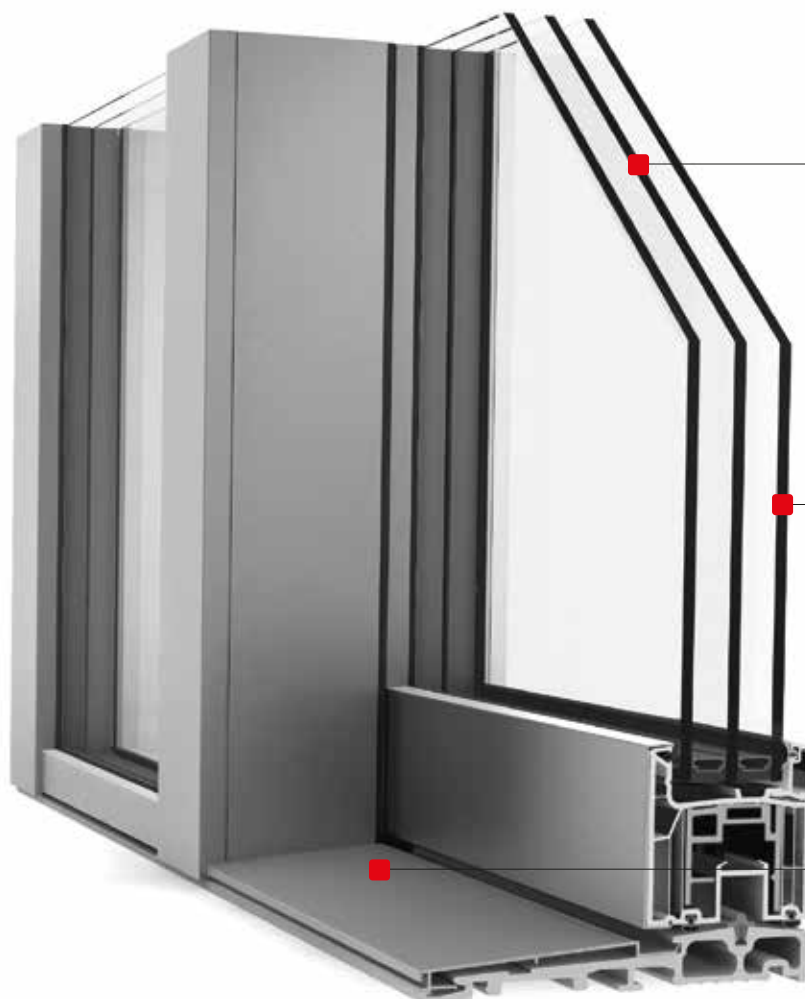

I-tec Connect

More light from large glazing up to 650 x 280cm. Sash up to 400kg.

ESG toughened glass as standard to prevent injury.

The low threshold provides comfortable access and makes it suitable for barrier-free construction.



Comfort Drive allows your lift & slide door to be opened via electric operation. Can be integrated into a Smart Home system.



Thermal insulation up to $U_w = 0.64 \text{ W}/(\text{m}^2\text{K})$



Noise reduction up to 43 dB



Security up to RC1N, RC2

*Create light and space
with large Lift & Slide doors*

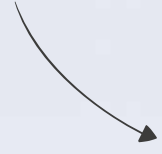

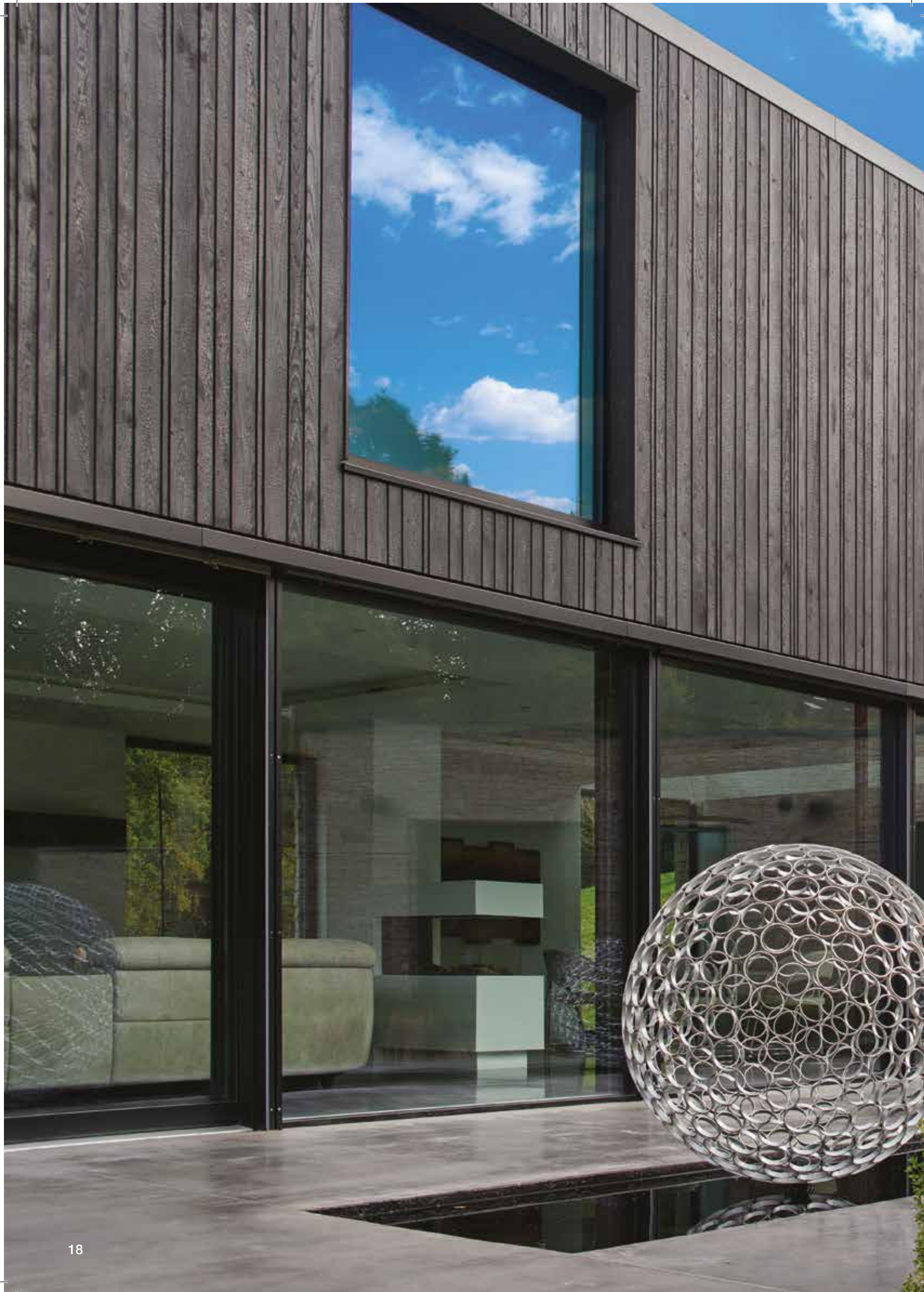

TIMBER-ALUMINIUM

STYLISH. MODERN. SUSTAINABLE.







HF 510

TIMBER-ALUMINIUM WINDOW

NEW



-  **Thermal insulation** U_w as low as 0.65 W/(m²K)
-  **Noise reduction** up to 43 dB
-  **Security** up to RC1N, RC2
-  **Locking** concealed
-  **Construction depth** 85 mm



*Rendering or over-cladding
will achieve slim sightlines.*



I-tec Core

I-tec Glazing

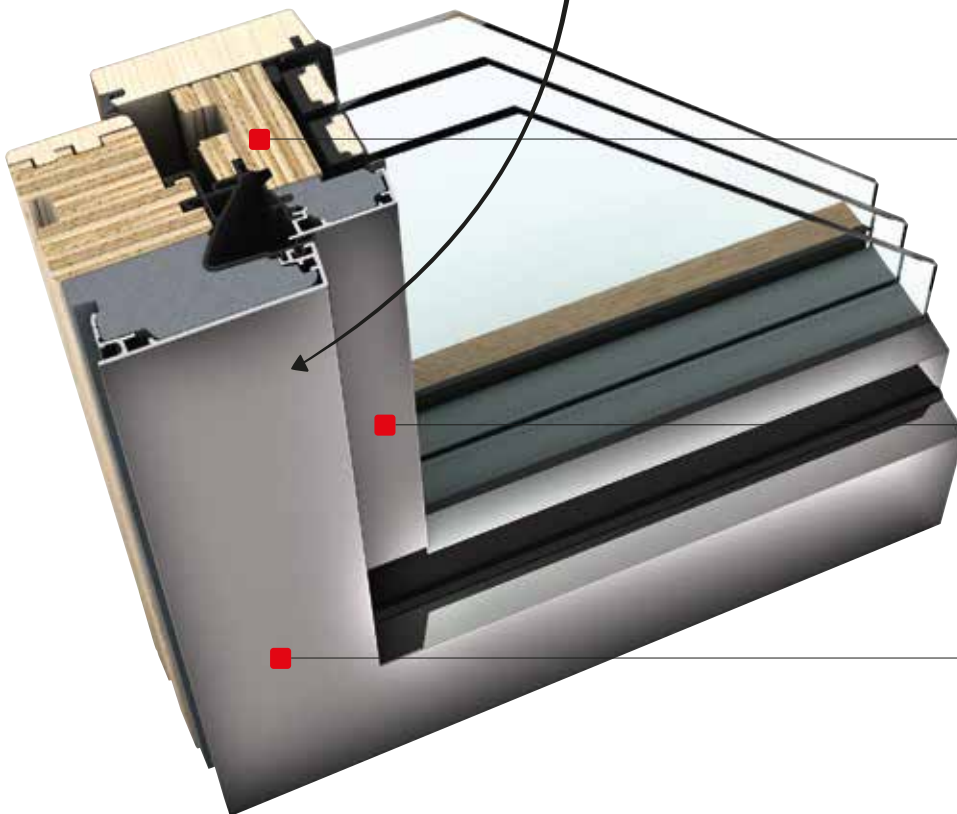

The I-tec Core makes this window exceptionally robust and stable, therefore making larger windows solutions possible. (I-tec Core pg. 43)

Slim, modern frame and even larger areas of glazing for increased light penetration and more comfortable living.

The square, linear features of the sash and frame make design style home pure the ideal window for modern architecture.

home pure



Internal View



I-tec Core



I-tec Glazing

HF 410

TIMBER-ALUMINIUM WINDOW



I-tec Core





I-tec Glazing

home pure

home soft

ambiente

studio

-  **Thermal insulation** U_w as low as 0.65 W/(m²K)
-  **Noise reduction** up to 45 dB
-  **Security** up to RC1N, RC2
-  **Locking** concealed
-  **Construction depth** 85 mm



HF 410

The unique I-tec Core technology of thin, laminated timber layers, makes the HF 410 exceptionally stable and robust, allowing the manufacture of even larger window sizes. The combination of timber, insulating foam and aluminium cladding provides superior thermal performance. Sustainably sourced timber options and a wide choice of colours offers unlimited interior design possibilities.

HV 450

TIMBER-ALUMINIUM WINDOW WITH INTEGRATED BLIND



I-tec Glazing

I-tec Shading





I-tec Core

I-tec Connect

home soft

ambiente

home pure

-  **Thermal insulation** U_w as low as 0.62 W/(m²K)
-  **Noise reduction** up to 46 dB
-  **Security** up to RC1N, RC2
-  **Locking** concealed
-  **Construction depth** 85 mm



HV 450

The thermally efficient HV 450, with blinds integrated between accessible glass panes, offers quadruple protection: sun, privacy, thermal and noise. With a choice of styles and colours, the integrated blinds are protected from wind, rain and dirt. The I-tec Shading solution offers operation of the blinds via a photovoltaic module using solar energy, therefore not requiring an external power source. Also available as hard wired or manual operation. Internorm shading options can be integrated into a Smart Home system.



HS 330

TIMBER-ALUMINIUM LIFT & SLIDE DOOR



ENERGY-EFFICIENT FRAMELESS

Fibreglass threshold for optimum thermal insulation

Frameless glazing achieved with fully rendered fixed elements

COMFORTABLE

Easy to lift and slide up to 400kg sash weight

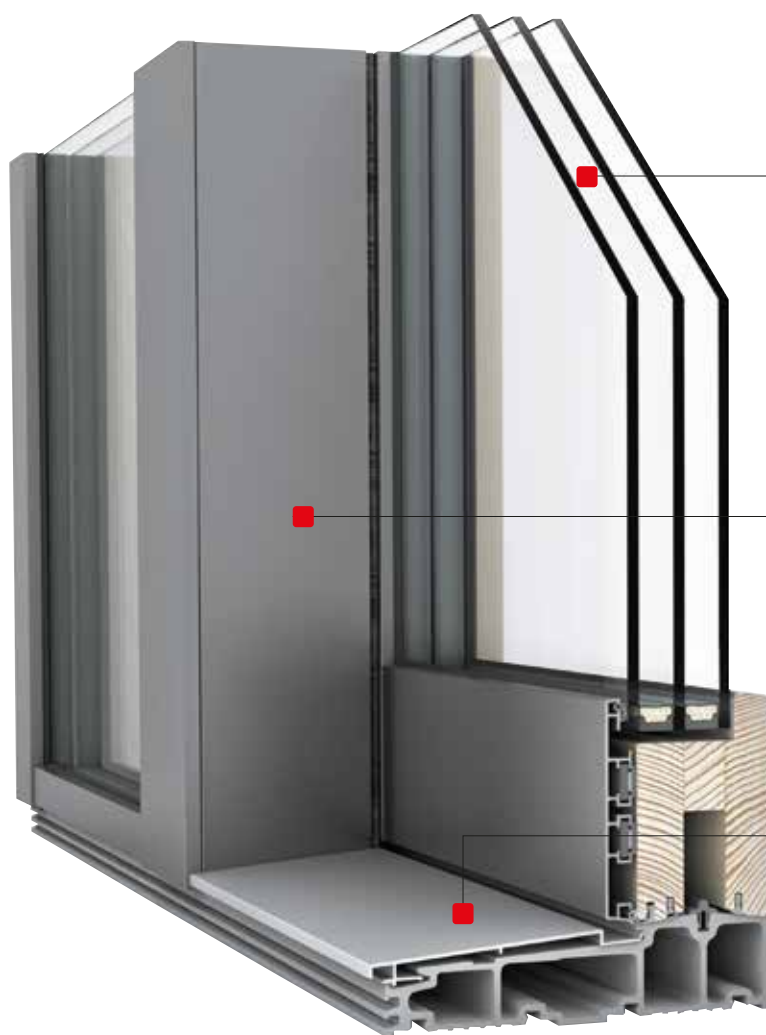

I-tec Glazing

I-tec Connect

Can be combined with fixed glazing for even large glazed areas.

Stylish external colour options – can be perfectly combined with the timber-aluminium windows HF 410, HF 510 and HV 450.

Energy-saving, low fibreglass threshold for optimal thermal insulation and stability.



Comfort Drive allows your lift & slide door to be opened via electric operation. Can be integrated into a Smart Home system.

 **Thermal insulation** up to $U_w = 0.73 \text{ W}/(\text{m}^2\text{K})$

 **Noise reduction** up to 40 dB

 **Security** up to RC1N, RC2

HX 300

PANORAMA



OPEN

Glass joint virtually invisible

BRIGHT

Large glazing up to 10.5m²

FRAMELESS

Frame almost entirely disappears into the facade.



Thermal insulation up to $U_w = 0.74 \text{ W}/(\text{m}^2\text{K})$



Noise reduction up to 47 dB



Create visual features with Integrated windows

Triple safety glass for optimal thermal insulation

Strong, glued multi-layered frame construction

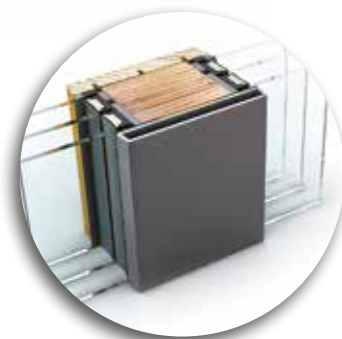
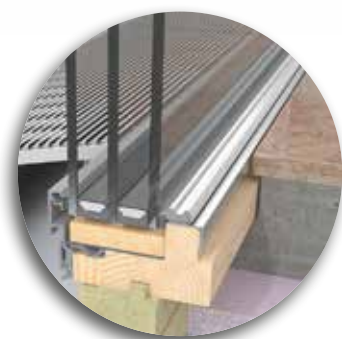
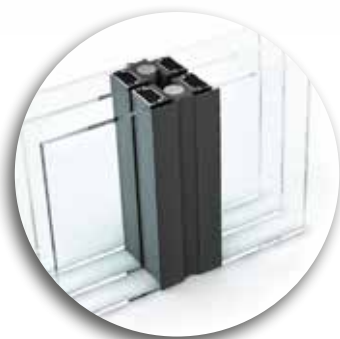

Why not add a glass-to-glass corner for uninterrupted views?



uPVC

NEW



KF 520

KF 510

KF 410

KF 310

KF 520

Thermal Insulation in W/(m²K)

ECLAZ® Coating	U _w = 0.70	U _w = 0.71	U _w = 0.71	U _w = 0.76	U _w = 0.70
Best Value	U _w = 0.63	U _w = 0.63	U _w = 0.62	U _w = 0.69	U _w = 0.63

Noise Insulation (dB)

33 – 46	34 – 46	34 – 47	33 – 45	33 – 46
---------	---------	---------	---------	---------

Security

RC2, RC3	RC2, RC3	RC1N, RC2	RC1N, RC2	RC2, RC3
----------	----------	-----------	-----------	----------

Locking

fully integrated	fully integrated	concealed	concealed	fully integrated
------------------	------------------	-----------	-----------	------------------

Dimensions in mm

Frame Construction Depth	90	90	90	71	93
Sightline frame/sash	85	95	113	107	85
Sightline flying mullion (2 sashes)	96	100	133	119	96
Sightline mullion (2 sashes)	148	147	187	170	148

Design

Fixed	X	X	X	X	X
Turn and Tilt/Turn	X	X	X	X	X
Tilt	X	X	X	X	X
Parallel sliding window		X	X	X	
Lockable door		X	X	X	
Lift & Slide door		X	X	X	
Doors with low threshold	X	X	X	X	X
Outward opening doors			X	X	

Gasket

Number	3	3	3	3	3
Colour external gasket	light grey	light grey	light grey	light grey	light grey/black

Georgian Bars stick-on and internal

in different widths			home soft	home soft	
in different widths as well as gold and lead bars			ambiente	ambiente	

Available in Design Styles

studio					studio
	home pure	home pure			
		home soft	home soft		
		ambiente	ambiente		

Further information on pages	10	11	12	13	10
-------------------------------------	----	----	----	----	----

uPVC-ALUMINIUM

TIMBER-ALUMINIUM

NEW

NEW

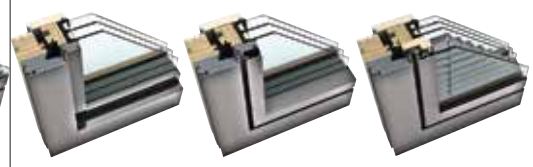

KF 510

KF 410

KF 310

KV 440

KV 350

HF 510

HF 410

HV 450

$U_w = 0.72$	$U_w = 0.71$	$U_w = 0.76$	$U_w = 0.78$	$U_w = 1.1$	$U_w = 0.72$	$U_w = 0.71$	$U_w = 0.97$
$U_w = 0.64$	$U_w = 0.62$	$U_w = 0.69$	$U_w = 0.64$	$U_w = 0.79$	$U_w = 0.65$	$U_w = 0.65$	$U_w = 0.62$
34 – 46	34 – 47	33 – 45	39 – 45	38 – 44	35 – 44	33 – 45	41 – 46
RC2, RC3	RC1N, RC2	RC1N, RC2	RC1N, RC2	RC1N, RC2	RC1N, RC2	RC1N, RC2	RC1N, RC2
fully integrated	concealed	concealed	concealed	concealed	concealed	concealed	concealed
93	93	74	93	74	85	85	85
95	113	107	118	112	99	108	108
100	133	119	144	130	106	124	124
147	187	170	198	181	156	173	173
X	X	X			X	X	
X	X	X	X	X	X	X	X
X	X	X	X	X	X	X	X
X	X	X			X	X	
X	X	X			X	X	
X	X	X	X	X	X	X	X
	X	X				X	
3	3	3	3	3	3	3	3
light grey/ black	light grey/ black	light grey/ black	light grey/ black	light grey/ black	black	black	black
	home soft ambiente	home soft ambiente	home soft ambiente	ambiente		home soft ambiente	home soft ambiente
	studio					studio	
home pure	home pure	home pure	home pure	home pure	home pure	home pure	home pure
	home soft	home soft	home soft			home soft	home soft
	ambiente	ambiente	ambiente	ambiente		ambiente	ambiente
11	12	13	14	15	20	22	23



Watch video of case study



Renovations...

TRANSFORM YOUR HOME WITH
INTERNORM TRIPLE GLAZING

This period property is a fantastic example of Internorm windows and doors being integrated into more traditional architecture. The original section of this stunning property in Hertfordshire was built in 1904 and extended over time. The previous golden oak uPVC double-glazed windows were replaced by Internorm triple-glazed Timber-Aluminium windows and French doors. The old uPVC bi-fold doors at the rear stopped functioning fully and the vertical bars took a lot of the light away from the kitchen area and the old bi-fold doors were replaced by our large lift & slide doors, which instantly brightened the interior and made a huge difference to the home.

With its integrated Georgian bars, the Internorm composite windows look like the originals from over 100 years ago but with the benefits of superior technical performance you get from Internorm products. As this property is situated near a busy road, the triple glazing made an enormous difference to the noise reduction and together with the I-tec Glazing dramatically improved the security of the property. The homeowner was delighted:

"Having recently had our windows and bifold doors replaced throughout our property with Internorm triple glazed units, any doubts about the value for money have gone entirely, now that I've experienced the product installed. Aesthetically the windows have transformed our property, but there are so many other benefits. I put a premium on security, and these are second to none. We enjoy more light into rooms with large expanses of glass and less obtrusive frames than we had before and the improvement in sound insulation – from relatively new double glazed uPVC units previously – is well beyond anything I expected."

Products installed: Timber-Aluminium HF 410 windows + French doors, HS 330 Lift & Slide Doors with Georgian bars.

Colours: Interior timber factory painted in Traffic White RAL9016. Exterior aluminium cladding in Jet Black RAL9005.

Speak to your local Internorm partner to see how your home can be transformed.



PERFECT COMBINATIONS

TRUE TO STYLE. INDEPENDENT OF MATERIALS. MATCHING.

Individual architecture increases the demand on window design, energy efficiency and comfort. With Internorm, functionality and design are not a contradiction. It is possible to perfectly mix and match uPVC-aluminium and timber-aluminium in one project.

Same design on the outside – choose between uPVC and timber on the inside

If you prefer a uPVC-aluminium window in the bathroom due to high humidity, but prefer the feel and look of a timber-aluminium window in the living room – no problem. The design style and exterior finish of your windows will look and remain the same. The difference is on the inside where you can choose between classic uPVC or natural timber.

Consistent architectural style throughout

No matter what design style you choose for your home - avant-garde, contemporary, traditional or timeless – Internorm offers you the perfect solution for combining materials and products to suit your particular need.

Combine with lift & slide doors

To ensure that you don't miss out on large scale glazing and more light in your home, you can even choose your lift & slide doors in uPVC-aluminium and timber-aluminium to match your windows to achieve a uniform look.



OUTSIDE – THE SAME



Aluminium

The aluminium cladding on the outside matches the design style of your house.

INSIDE – YOUR CHOICE



uPVC

uPVC is longlasting, maintenance free and perfect for rooms with high humidity, e.g. bathrooms.



Timber

Timber has a natural, warm feel and is ideal for living spaces and bedrooms.



JULIET BALCONY

EVEN SMALLER ROOMS FEEL MORE SPACIOUS.

Balconies and terraces are no longer as popular as they once were and often not an option in city centres for structural reasons. However, large glass areas are integral to modern architecture.

Juliet balconies are the perfect solution for letting more light into a room, providing uninterrupted views, and creating beautiful design features. Made with laminated safety glass and stainless steel trim, Internorm's Juliet balconies are uniquely integrated into the door frame and factory fitted.

Please ensure that minimum heights comply with Building Regulations to prevent falling.



Juliet balcony options



Option with laminated safety glass balustrade, including stainless steel trim



Option with round stainless steel rail



Option with square stainless steel rail



SUN AND INSECT PROTECTION

MIX & MATCH. INTEGRATED. MANY VARIATIONS.

Sun and insect protection can be combined with the window systems to provide added functionality and to enhance the facade of your house. They can also be integrated into your Smart Home system and conveniently controlled from your smartphone or tablet.

Integrated blinds: Sun and privacy protection integrated between glass panes. Choose from Roman, Venetian or black-out Duette blinds, also available with solar powered I-tec shading.

Internal blinds: Mounted on the window sash, it can be colour matched to the internal window frame.

Raffstores: Optimum control of light and solar gain with adjustable slats. Optional RETROLux louvres. Can be combined with fly screen. Ideal for lift & slide doors.

Internal Venetian blinds: Optimum control and guidance of light and warmth through adjustable slats. Can be combined with insect protection.

External roller/mini-roller shutters: Delivered separately or fitted to window. Can be combined with fly screen.

Fly screens: Available with friction-fit, turn or sliding frames, or pull-down roller mechanism. Can be combined with sun protection options.

Pleated fly screen: Space-saving and perfect retrofit solution, suitable for lift & slide doors.

Window shutters: Made from aluminium, available in many designs. Can be combined with fly screen.



Raffstores



I-tec Shading

Integrated blind



Internal blind



External roller shutter



Mini exposed roller shutter



Pull-down fly screen



Turn or fixed frame



Sliding frame



Pleated fly screen



RAFFSTORE EXTERNAL BLINDS

AVOID OVERHEATING. REDUCE COSTS.

Did you know that smart controlled raffstores can reduce room temperature in summer by up to 10°C compared to unshaded rooms?

Particularly on south-facing rooms it is important to include shading to large areas of glazing to avoid overheating during the summer months. Modern raffstore systems can be integrated into Smart Home systems and help to control solar radiation and light transmission, therefore contributing to passive cooling in summer and solar heating in winter.

Up to 50% less cooling energy

Did you know that cooling a room by 1°C with air conditioning uses three times more energy than increasing heating by 1°C.

Up to 30% less energy consumption

Smart controlled raffstores considerably reduce energy consumption by passive cooling and solar heating.

Reduce electricity costs by up to 80% by not using artificial lighting

Raffstore allow you to control the amount of sun entering your home and the specially designed slats effectively direct daylight into the interior.

Up to 8.5 tonnes of CO₂ saved

One raffstore can save about 8.5 tonnes of CO₂ in its lifetime. The manufacture, use and disposal of a raffstore only creates around 150kg of CO₂.

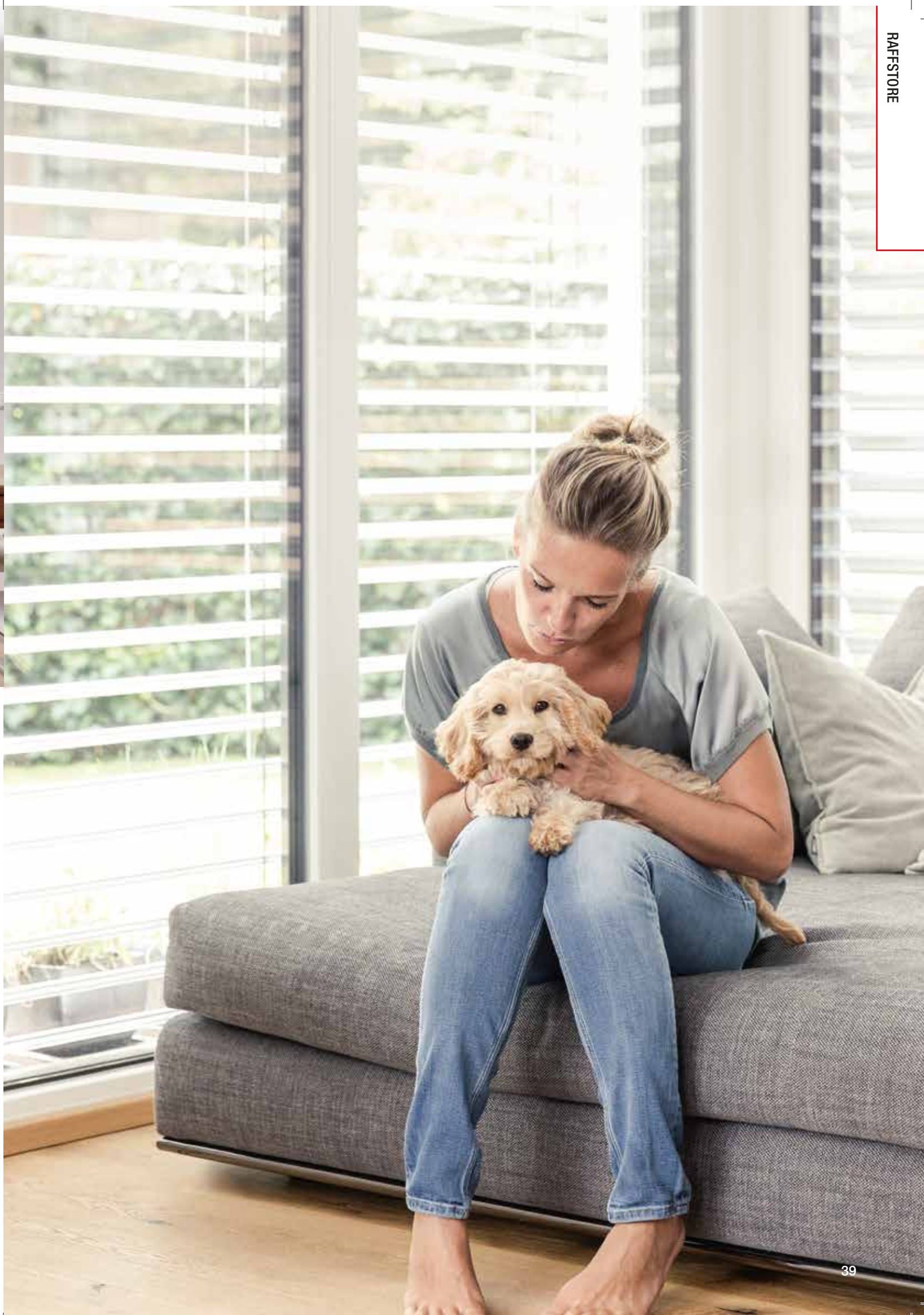



RAFFSTORE

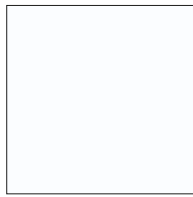

RAL 9016
Traffic white



RAL 1015
Light ivory

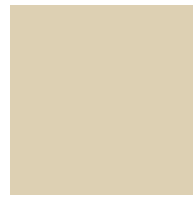

Light beige



RAL 7047
Telegrey



RAL 6005
Moss green

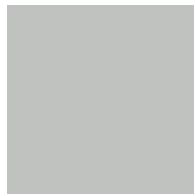

RAL 7038
Agate grey



RAL 9006
White aluminium



RAL 9007
Grey aluminium

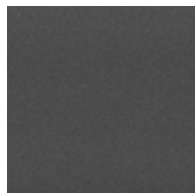

DB 703



RAL 7016
Anthracite grey

ROLLER SHUTTERS



white

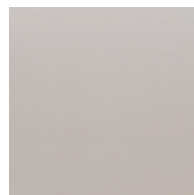

grey



creme



beige



Grey aluminium

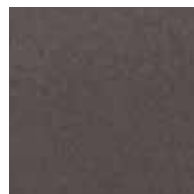

DB703 aluminium-grey



aluminium-anthracite
grey



aluminium-natural

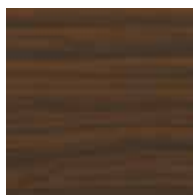

aluminium-wood dark



aluminium-brown

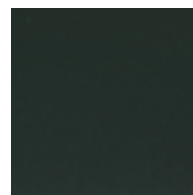

aluminium-moos green



INTEGRATED & INTERNAL BLINDS (VENETIAN)



DUETTE®



ROMAN BLINDS

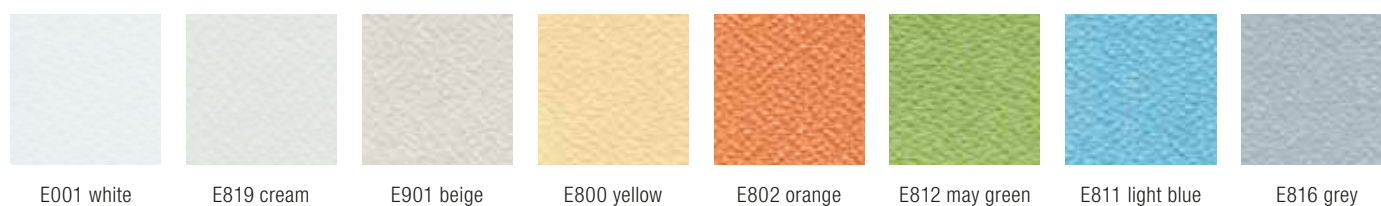

I-TEC INNOVATIONS

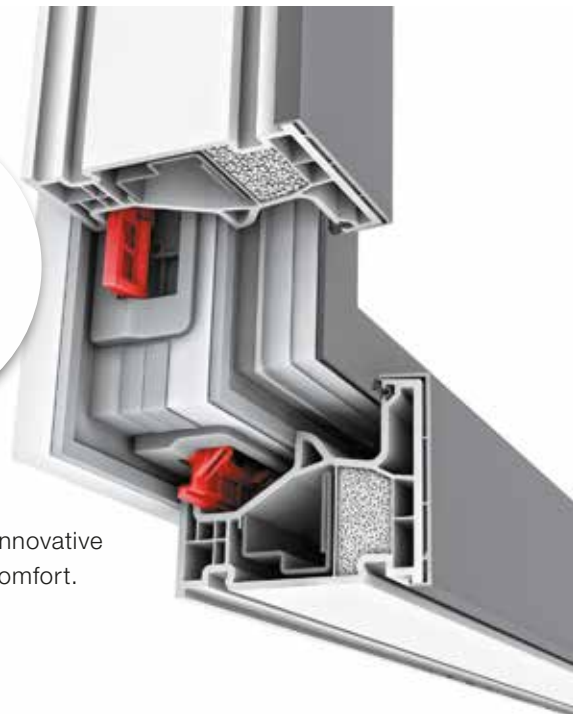

NEW STANDARDS FROM INTERNORM.

Under the heading **I-tec**, Internorm has been developing a series of revolutionary, innovative technologies to meet the increasing demands on design, technology, quality and comfort.

- **I-tec Secure**
- **I-tec Core**
- **I-tec Shading**
- **I-tec Glazing**
- **I-tec Insulation**
- **I-tec Connect**

Discover Internorm's innovative technologies and find out why I-tec is so unique.

I-tec Secure

FEEL SAFE

UNRIVALLED, FULLY INTEGRATED
LOCKING UP TO RC3

ADVANTAGES

- Enhanced security up to RC3 available, achievable with integrated flaps
- Levering of window is practically impossible
- Clean look as locking hardware is concealed
- Easy to clean window frame
- Modern glass architecture with slim sightlines

Feeling safe and secure in your home is paramount. The unrivalled I-tec Secure locking system ensures that your windows provide reliable protection. The customary locking pegs are replaced by flaps that securely lock the window sash to the frame, making levering of the window practically impossible. The concealed hardware makes cleaning the windows easier.

I-tec Secure is integrated into the new KF 510 and KF 520 uPVC and uPVC-Aluminium systems. It can reach security class RC2N with an optional lockable handle and is available up to security class RC3 on request.

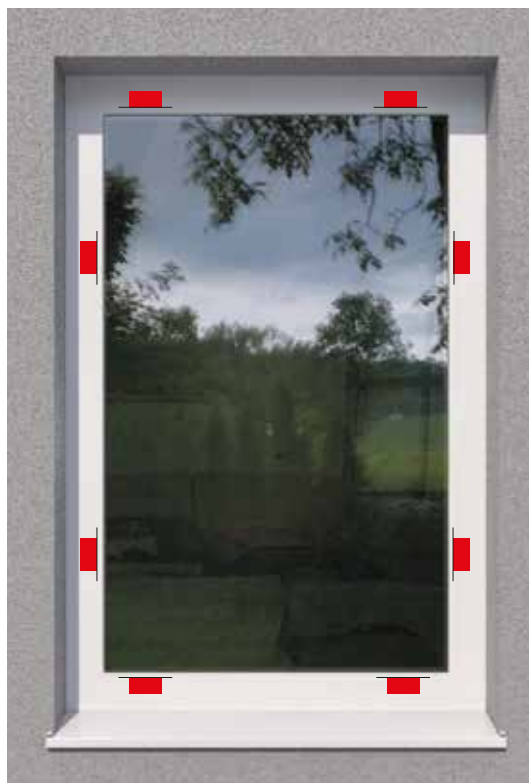

Discover more about I-tec Secure
uk.internorm.com/i-tec-innovations/i-tec-secure/

I-tec Core

STRENGTH AND STABILITY

WIDE SELECTION OF TIMBER OPTIONS

ADVANTAGES

- Highly stable core in window frame and sash
- Slim sightlines for more light
- Match timber types and colours to your interior – large choice of colours and timbers
- Attractive price-performance ratio
- Option to match windows and lift & slide doors.

With I-tec Core, Internorm windows are able to achieve high stability and strength. The thin laminated layers of timber

are exceptionally resistant, durable and strong, enabling the manufacture of large windows and lift & slide doors. This high-tech material is sustainable, and due to its strength, suitable for large dimensions. The wide choice of timber, such as spruce, larch, oak, ash and walnut, used on the inside of our windows and lift & slide doors, can be matched to your individual interior decoration, furniture, flooring and doors.



Discover more about I-tec Core
uk.internorm.com/i-tec-innovations/i-tec-core/



Discover more about the I-tec Shading.
uk.internorm.com/i-tec-innovations/i-tec-shading/

I-tec Shading

SOLAR POWERED

SELF-SUFFICIENT SUN PROTECTION

ADVANTAGES

- No electricity needed due to the photovoltaic module
- Use of energy gain in winter – reduction of heating costs
- Automatic functions such as day/night recognition and measuring of solar irradiation
- Manual control available directly at the window frame
- Convenient control also available via Smart Home solutions
- Photovoltaic module and sun protection integrated between glass panes

The clever I-tec Shading is the perfect solution for adding sun protection and privacy and to stop overheating. The energy required to operate the integrated blind is generated by a photovoltaic module or solar panel. No hard wiring is necessary as the unit is totally self contained within the window. Available as Venetian, Roman or Duette option, the blind can be operated via a remote control or integrated into a Smart Home system. Available with KV and HV window systems.

I-tec Glazing I-tec Insulation

CONTINUOUSLY EFFICIENT

SAFETY ALL AROUND

ADVANTAGES

I-TEC GLAZING

- Maximum burglary protection
- Increased stability
- Increased thermal insulation
- Improved noise reduction

I-TEC INSULATION

- Granulate instead of foam
- Improved thermal insulation
- Hollow chambers filled on all sides

To ensure maximum security, Internorm windows are fitted with **I-tec Glazing** as standard. This technology means that glass panes are glued to the sash all the way round. This considerably improves stability, thermal insulation, noise reduction and burglary protection.

I-tec Insulation is standard for three Internorm window systems: KF 410, KF 510 and KV 440. A granulate is pushed into the hollow chambers under pressure and therefore completely fills them all the way round. I-tec Insulation provides considerable improvement in thermal insulation.

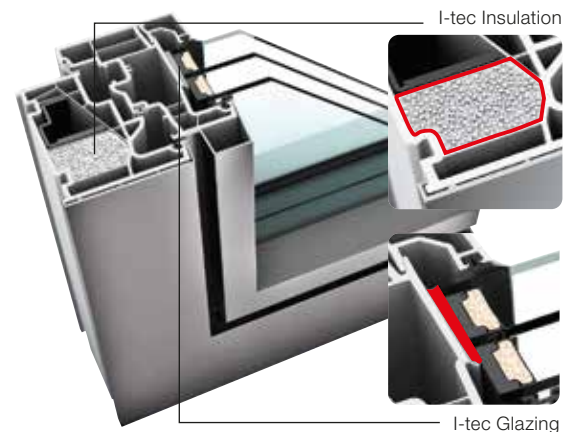

Discover more about these I-tec innovations.
uk.internorm.com/i-tec-innovations/i-tec-glazing/



Discover more about I-tec Connect.
uk.internorm.com/i-tec-innovations/i-tec-connect/

I-tec Connect

SMART HOME READY

CONTROL AT YOUR FINGERTIPS

ADVANTAGES

- Intelligent control around the window
- Mobile operation of I-tec Ventilation, I-tec Shading, and fanlights
- Opening monitoring of your windows
- Direct integration into central SmartHome solutions

Whether you are at home or on the road, intelligent automation allows you to control heating, lighting, audio, security, shading, and much more.

I-tec Connect offers a range of intelligent window products that can be integrated into a Smart Home system. Window opening monitoring, I-tec Ventilation, I-tec Shading, blinds or fanlights can be operated via an app on your smartphone or tablet. A simple finger tap will open or close blinds, adjust the light control or regulate the airflow of the ventilation. Even the electric Comfort Drive on a lift & slide door can be connected to your home network via your Wifi hub.



ECLAZ® THE PREMIUM GLASS COATING

NOW IN EVERY INTERNORM WINDOW

Unlike artificial light, sunlight does not just create a brighter environment, the colour spectrum also has positive and uplifting biological and psychological effects that can impact your health and wellbeing of humans.

Improve natural daylight transmission with ECLAZ® premium glass coating

To allow even more natural light to flood your home, Internorm offers the premium ECLAZ® glass coating as standard across its whole product range.

COMPARED TO CONVENTIONAL GLASS, ECLAZ® OFFERS:



More light & transparency

- The special coating allows more daylight to enter the interior, therefore making it brighter and friendlier.
- Enjoy a clearer view of the outside. The external reflection or mirror effect is also low and the glass is colour-neutral from the outside.



Improved health & productivity

- ECLAZ® helps to regulate your inner balance. Blue light from the sun helps to regulate your natural sleep and wake cycle, elevate moods and increase the feeling of well being.
- It also helps to boost alertness, improve productivity and learning.



Increased happiness & well-being

- Daylight has a balanced light spectrum and regulates the serotonin balance, which is responsible for well-being and life energy. Halogen bulbs, fluorescent tubes and LEDs lack these important light frequencies. ECLAZ® floods the house with daylight.
- 77% more light transmission of triple glazing with ECLAZ® helps to boost health and well-being, especially in the darker autumn and winter months.



Better energy efficiency & higher cost savings

- Less heat loss: ECLAZ® provides excellent thermal insulation, therefore reducing heating costs.
- Greater energy savings: 60% improvement in solar gain with triple glazing resulting in lower heating costs and higher energy efficiency.



Get more as standard

- ECLAZ® is fitted as standard in every Internorm window.
- No additional costs. You enjoy the benefits of this premium glass coating without having to pay more.



FEEL SAFE AND SECURE

RELIABLE. EFFECTIVE. PATENTED.

To feel safe and secure in your own home, burglary protection as well as maximum security for children are fundamental requirements. Quality windows largely contribute to this feeling of safety and with the proven technologies from Internorm, you can protect your family and make it difficult for intruders to enter your home.



Security locking elements

All Internorm window systems are equipped with standard security hardware. Solid, yet discreet silver designer locking elements, together with octagonal mushroom cams in the frame, provide secure locking (except KF 510 and KF 520).



I-tec Secure (KF 510 and KF 520)

Internorm's revolutionary locking technology guarantees maximum protection. When locking the window, flaps open and press into the frame on all sides, making it virtually impossible to lever the window.



Security handle

The new Secustik® window handle contain a jamming-device which provides integrated security. This makes it more difficult to move the window fitting unlawfully from outside. (standard on KF 510 and KF 520 uPVC and uPVC-aluminium windows).



Lockable handles

Lockable handles offer optimal security for use by children as well as burglary protection. The window is locked with a key and cannot be opened from the inside or outside.



Concealed hardware

Concealed hardware prevents windows from being levered out of their hinges, with the added benefit of making windows look neat and easy to clean.



I-tec Glazing

Thanks to Internorm's patented glazing technology, the glass pane cannot be pushed out. The glass is glued into the frame all the way round, making it more secure and stable.

Most Internorm window systems include this I-tec innovation as standard.



Electronic opening detector

Discreet and reliable, these hard wired or wireless locking sensors report whether windows or French doors are open, tilted or locked.











Laminated glass

Unlike standard glass, laminated glass does not shatter when broken. A tough interlayer bonded between two glass panes ensures that the glass stays in the frame and does not cause injury.



INTERNORM HANDLE COLOURS

-  F1 Aluminium natural
-  F9 aluminium steel
-  RAL910 white
-  F9714m black matt
-  Brass polished
-  Chrome satin finish
-  Chrome/stainless steel matt
-  Brass matt/aluminium steel

WINDOW HANDLES

OUR ENTIRE RANGE AT A GLANCE

The Internorm window handles fit comfortably into your hand and are available as round, square or flat option. We recommend matching the window handles to your existing interior doors and furniture.



**Lift & slide door handle
G80**
Ill. in black matt
Item no. 36133

available in the colours



**Lift & slide door handle
Dallas**
Ill. in aluminium natural
Item no. 36424

available in the colours



**Lift & slide door handle
Softline**
Ill. in aluminium natural
Item no. 32447

available in the colours



NOTE: Not all handle options are available for each window system. Your Internorm distribution partner will be happy to advise you on the possible combinations.



Handle G80 flat cylinder key hole cover plate
 III. in aluminium natural
 Item no. 36435

available in the colours



Handle G80
 III. in aluminium natural
 Item no. 36404 (item no. 36505 for KF310/KF320/KV350)

available in the colours



Handle G80 lockable
 III. in aluminium natural
 Item no. 36400

available in the colours



Handle G80 with push button
 III. in aluminium steel
 Item no. 36394

available in the colours



Secustik® handle G80
 III. in aluminium natural
 Item no. 36428

available in the colours



Secustik® handle Austin flat cylinder key hole cover plate
 III. in black matt
 Item no. 36170

available in the colours



SecuForte®
 III. in black matt
 Item no. 36132

available in the colours



Secustik® handle Dallas
 III. in aluminium natural
 Item no. 36426

available in the colours



Standard handle
 III. in aluminium natural
 Item no. 33899
 (item no. 36504 for KF310/KV350)

available in the colours



Handle with push button
 III. in aluminium natural
 Item no. 33885

available in the colours



Designer handle Bruxelles
 III. with chrome satin finish
 Item no. 34592

available in the colours



Handle Amsterdam
 III. in aluminium natural
 Item no. 36416

available in the colours



Designer handle Athanai
 III. in brass matt/aluminium steel
 Item no. 34594

available in the colours



Handle lockable
 III. in brass
 Item no. 33886

available in the colours



Designer handle Atlanta
 III. in brass
 Item no. 34750

available in the colours



COLOURS

INTERNAL WINDOW OPTIONS

uPVC

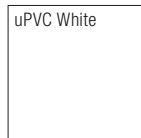

DECOR FOILS	KF 520	KF 510	KF 310	KV 350	KF 410 studio	KF 410 home p.	KF 410 home s.	KF 410 ambiente	KV 440 home p.	KV 440 home s.	KV 440 ambiente	KS 430
Golden Oak			X	X			X	X		X	X	X
Brilliant White			X	X	X	X	X	X	X	X	X	X
Cream White			X	X			X	X		X	X	X
Dark Grey	X	X	X	X	X	X			X			X

Timber

standard colour **SPRUCE**, varnished
HF 410/510 HV 450 HS 330

FI500	X	X	X
FI501	X	X	X
FI502	X	X	X
FI503	X	X	X
FI505	X	X	X
FI506			X
FI507			X

standard colour **SPRUCE**, varnished
HF 410/510 HV 450 HS 330

FI508			X
FI509			X
FI510	X	X	X

standard colour **SPRUCE**, opaque
HF 410/510 HV 450 HS 330

FI916	X	X	X
-------	---	---	---

Standard colour **LARCH**, varnished
HF 410/510 HV 450 HS 330

LA600	X	X	X
LA604 oiled	X	X	X

OAK
HF 410/510 HV 450 HS 330

EI700	X	X	X
EI701	X	X	X
EI706 oiled	X	X	X
EI707 oiled	X	X	X

ASH
HF 410/510 HV 450 HS 330

ES800	X	X	X
-------	---	---	---

WALNUT
HF 410/510 HV 450 HS 330

NU400	X	X	X
-------	---	---	---

EXTERNAL WINDOW OPTIONS

uPVC

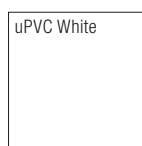

Please note that not every colour is available for every window.

Due to printing and manufacturing technology colour deviations between illustrations and original products may occur.

Your Internorm partner will be happy to show you original colour samples.

Aluminium cladding

STANDARD COLOURS*



hirest-COLOURS***



HDS COLOURS**



STAINLESS STEEL COLOURS

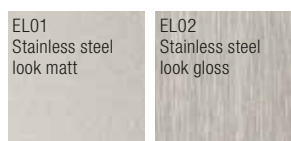

* **Highly weather-resistant**, except M916 (facade quality).

** Intensive colour, variation possible.

*** For surface options **HM** (highly weather-resistant standard colour), **HF** (highly weather-resistant fine structure), **HFM** (highly weather-resistant fine structure metallic), a special highly weather-resistant powder coating is used.

Please note

SPECIAL COLOURS

The Internorm RAL colour range (facade quality) offers even more options. These colours are available for external aluminium cladding and internal timber.

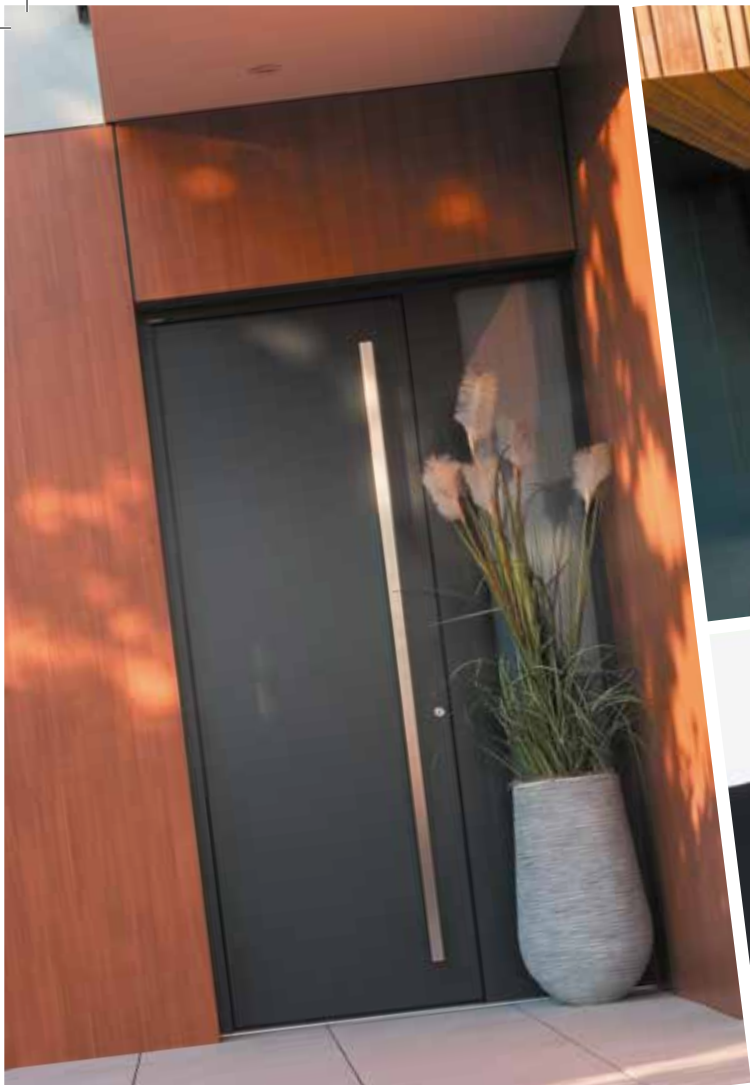

ENTRANCE DOORS

BESPOKE AND INDIVIDUAL



Make a statement with a stylish entrance

Each Internorm entrance door is created to your individual requirements. Choose from different designs, colours, finishes, handles and glass options. You can even add a fingerprint scanner and link your entrance door to your Smart Home system - the choice is yours.

To make it even easier for you to decide on the perfect door for your home, use our great **Door Designer** tool on our website - simply scan the QR code below and get creative! You can upload an image of the front of your house and design your Internorm entrance door to suit any architectural style.

Your local Internorm partner will also be happy to assist.

Discover more about Door Designer.
uk.internorm.com/internorm-door-designer/



SERIES.F

FLUSH & LINEAR

Solid flush doors keep your home private. Create your own minimalist entrance door with discreet groove milling and trims. A choice of straight or recessed handles will add to the overall design to create an impressive and modern entrance area.

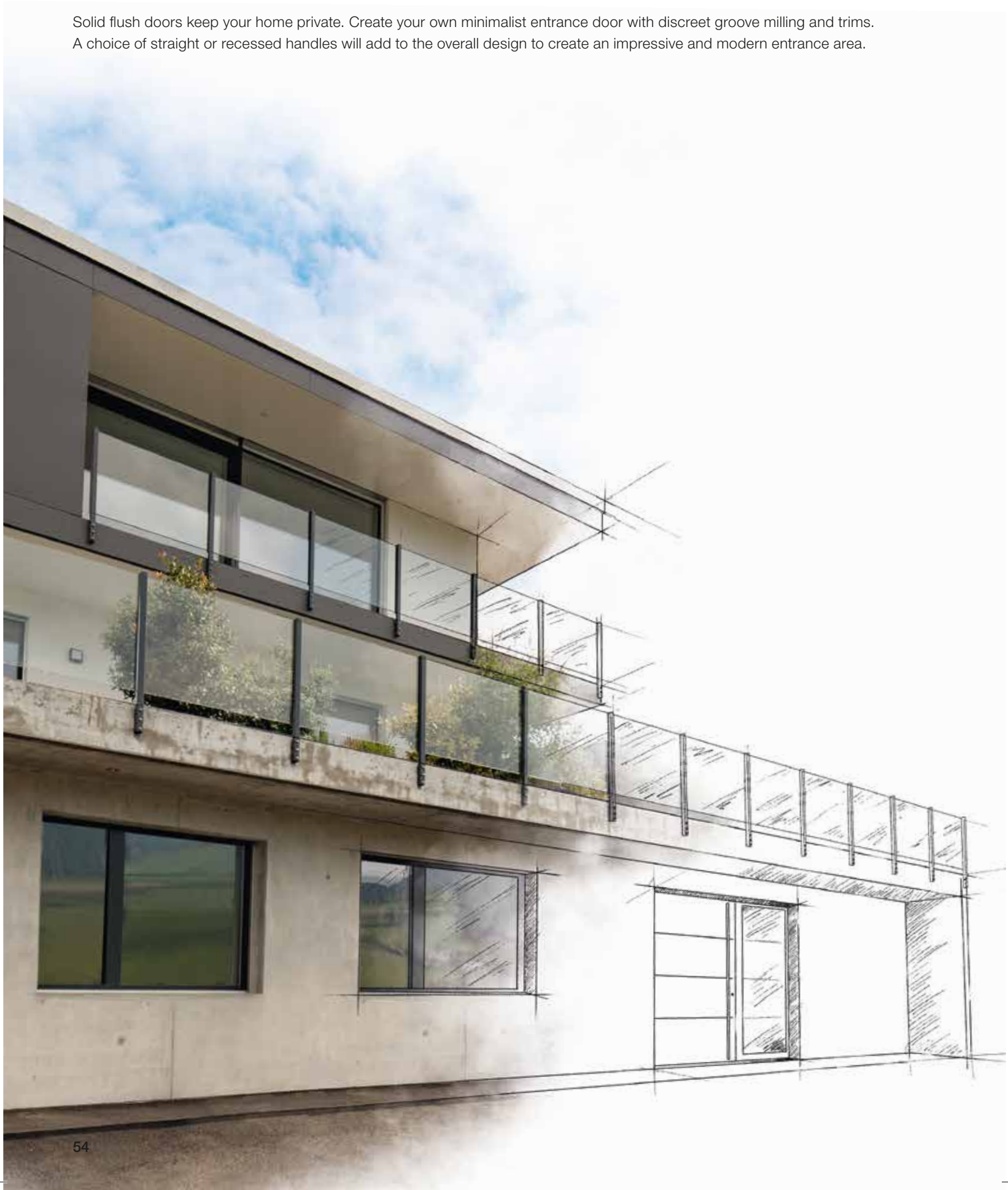



FG

Colour: HFM14
Handle: EGS01
Order no: F0003

AT 540 AT 530 AT 520 AT 500 HT 410 HT 400



FJ

Colour: Frame RAL 9005
Sash: SD05 Art-Corten
Handle: KGS04
Decor: Alu trim
Order no: F004

AT 540 AT 530 AT 520 AT 500 HT 410 HT 400

Real wood in antique finish -
each door is unique.



FO

Colour: HFM05
Handle: RGS01
Decorative strip: Alunox 20mm
Order no: F0005

AT 540 AT 530 AT 520 AT 500 HT 410 HT 400



FD

Colour: Frame HM716
Sash: SD10, HM716
Handle: RGS05
Special glass: Dark Grey
Order no: F0002

AT 540 AT 530 AT 520 AT 500 HT 410 HT 400



FP

Colour: Frame HM704,
Sash HM704, M916
Handle: KGS03
Order no: F0006

AT 540 AT 530 AT 520 AT 500 HT 410 HT 400



FU

Colour: Frame HM716
Sash: HM712
Handle: SG13
Order no: F0010

AT 540 AT 530 AT 520 AT 500

Black as well as stainless steel coloured trim give these doors a very special look.



FT

Colour: Frame RAL9005
Sash: SD09 Art-Carrara
Handle: SG17 black
Decor: Alu trim
Order no: F0009

AT 540 AT 530 AT 520



FS

Colour: HFM04
Handle: GSI40
Decor: Alu trim
Order no: F0008

AT 540 AT 530 AT 520 AT 500 HT 410 HT 400

TRENDSETTER

Doors in the ‚Art‘ category are not only eye catching, they are all unique. Each door has its own individual surface and in combination with metal trim or side lights they become a style focus.



FR

Colour: Frame RAL9005
 Sash: SD08 Art-Basalt
 Handle: GKV03 black
 Decor: Alu trim
 Order no: F0007

- AT 540
- AT 530
- AT 520
- AT 500
- HT 400
- HT 410



FA

Colour: Frame RAL9005
 Sash: SD07 Art-Stone
 Handle: KGS04
 Order no: F0001

- AT 540
- AT 530
- AT 520
- AT 510
- AT 500
- HT 410
- HT 400

SERIES.V

MODERN & VISIONARY



Stunning new designs and exceptional quality meet even the most demanding ideals of modern living. Our new designer doors combine elegance and individuality and surprise with stylish detailing.



Cleverly positioned glass sections create an elegant look.



VK

Colour: Frame HM819
Sash: HM819, RAL9005
Handle: GPRV black
Order no: V0005

AT 540 AT 530



VN

Colour: Frame HM712
Sash: HM712, RAL9005
Glass: Satinato white
Order no: V0002

AT 540 AT 530



” Every time you enter your house, you should get that special feeling of being at home.
Denis Vesel, Founder VESEL design “

VG

Colour: Frame RAL9005
Sash: SD10 Antique wood
Handle: GKVV black
Order no: V0003

AT 540 AT 530



VD

Colour: RAL9005
Handle: GSHG black
Order no: V0001

AT 540 AT 530



VP

Colour: Frame RAL9005
Sash: SD03 Art-Concrete, RAL9005
Handle: GSIV black
Order no: V0004

AT 540 AT 530

SERIES.P

BALANCED & STRUCTURED

This extensive range of doors impresses with its simplicity and symmetry. Whether you opt for a full length slim glass window or prefer perfectly aligned smaller windows in the centre or the side, the choice is yours.

To create an even more individual entrance door, you have the option to add milled grooves or decorative trims.



WOW EFFECT

Tactile ceramic surfaces create cutting edge entrance doors. They become a focal point within any architectural style.



PG

Colour: Frame HM721
 Sash: SD06 Art-Steel
 Handle: RGS02
 Glass: Satinato white
 Order no: P0004

AT 540 AT 530 AT 520 AT 510 AT 500 HT 410 HT 400



PM

Colour: Frame RAL9005
 Sash: SD07 Art-Stone
 Handle: KGS05
 Glass: Satinato white
 Order no: PO0007

AT 540 AT 530 AT 520 AT 510 AT 500 HT 410 HT 400



PA

Colour: Frame RAL9005
 Sash: HGS01 black
 Glass: Satinato white
 Order no: P0001

AT 540 AT 530 AT 520 AT 510 AT 500 HT 410 HT 400



PS

Colour: HM817
 Handle: GSI03 black
 Motif glass: MP43FE
 Order no: P0012

AT 540 AT 530 AT 520 AT 500 HT 410 HT 400



PJ

Colour: HF113
Handle: KGS03
Glass: Satinato white
Order no: P0005

AT 540 AT 530 AT 520 **AT 500** HT 410 HT 400



PK

Colour: M916
Handle: RGS03
Glass: Satinato white
Order no: P0006

AT 540 AT 530 AT 520 AT 500 HT 410 HT 400



PP

Colour: HFM12
Handle: RGS05
Glass: Satinato white
Order no: P0009

AT 540 AT 530 AT 520 AT 510 AT 500 HT 410 HT 400



PN

Colour: Frame HM907
 Sash: HM907, M916
 Handle: GKV03
 Glass: Satinato white
 Alunux glass frame
 Order no: P0008

AT 540 AT 530 AT 520 AT 500 HT 410 HT 400



PQ

Colour: Frame HM721
 Sash: HM721, HM907
 Handle: SG18
 Glass: Satinato white
 Order no: P0010

AT 540 AT 530 AT 520 AT 500 HT 410 HT 400

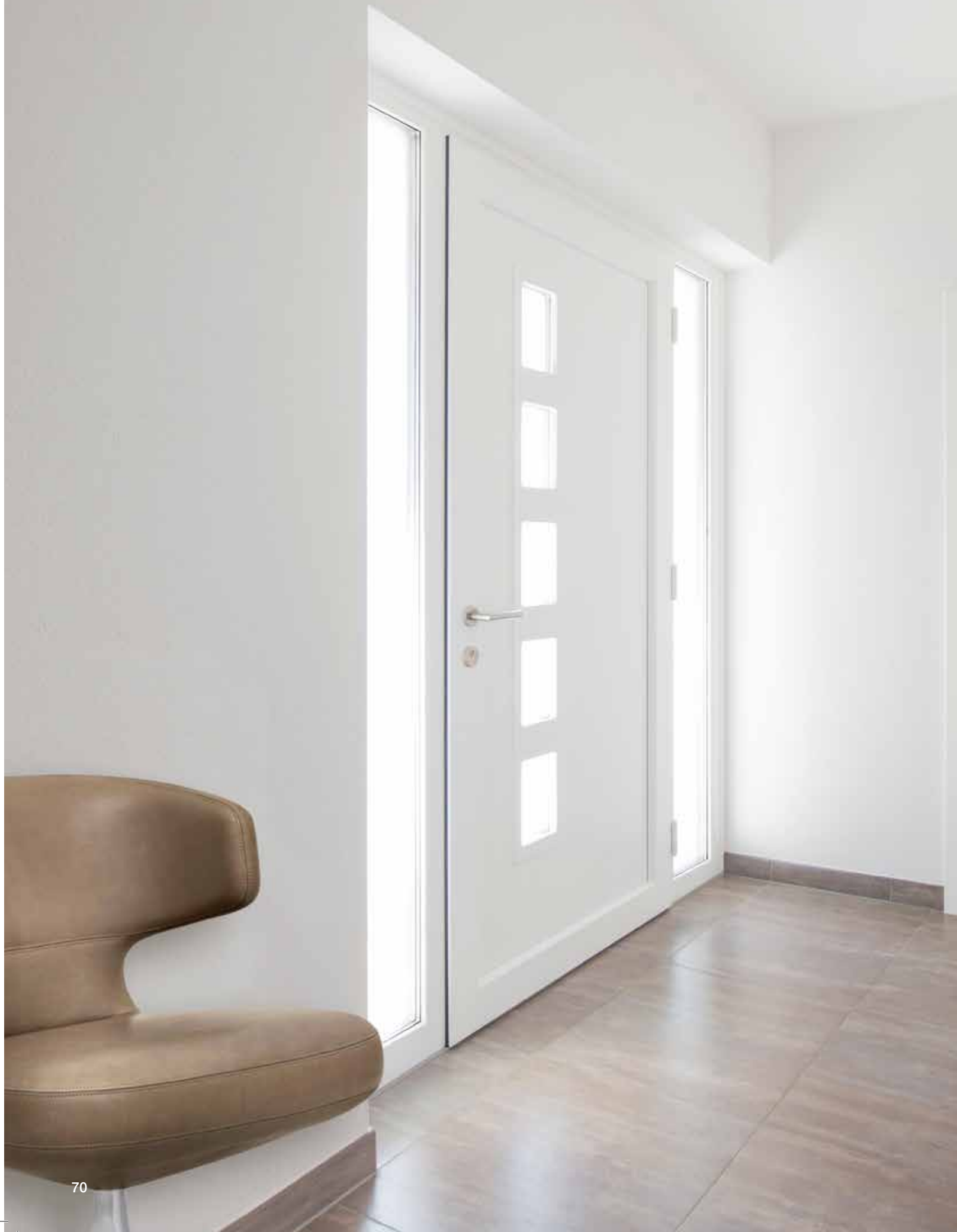



PE

Colour: HM716
 Handle: EGS01
 Glass: Satinato white
 Order no: P0003

- AT 540
- AT 530
- AT 520
- AT 500
- HT 410
- HT 400



PR

Colour: HM716
 Handle: RGS02
 Glass: Satinato white
 Order no: P0011

- AT 540
- AT 530
- AT 520
- AT 510
- AT 500
- HT 410
- HT 400

SERIES.D

DISCREET & ELEGANT

This beautifully designed range focuses on discreet, narrow glass windows and rectangular cut-outs, enhancing the overall appearance. Milled grooves and decorative trims add further individual touches.





DG

Colour: Frame RAL9005

Sash: HM704

Handle: SG17

Glass: Satinato white

Alunox glass frame

Decorative strip: Alunox 20mm

Order no: D0004

AT 540 AT 530 AT 520 AT 500 HT 410 HT 400



DD

Colour: HM716
 Handle: GOK60
 Glass: Satinato white
 Decor: Alu trim
 Decorative strip: Alunox 20mm
 Order no: D0003

AT 540 AT 530 AT 520 AT 500 **HT 410** HT 400



DP

Colour: RAL5010
 Handle: GD25
 Glass: Satinato white
 Order no: D0007

AT 520 **AT 500** HT 400

Black keyhole rosette available to match black door handle.



DH

Colour: Frame RAL9017
 Sash: SD03 Art-Concrete
 Handle: KGS04 black
 Decor: Alu trim
 Glass: Satinato white
 Order no: D0005

AT 540 **AT 530** AT 520 AT 500 HT 410 HT 400



DR

Colour: Frame RAL9005
 Sash: SD10 Antique wood
 Handle: HGS03 black
 Decor: Alu trim
 Glass: Satinato white
 Order no: D0008

AT 540 **AT 530** AT 520 AT 500 HT 410 HT 400



DM

Colour: Frame HFM12
 Sash: HFM12, M916
 Handle: HGS04
 Glass: Satinato white
 Order no: D0006

AT 540 AT 530 AT 520 **AT 500** HT 410 HT 400



DB

Colour: Frame HM721
 Sash: SD05 Art-Corten
 Handle: KGS01
 Glass: Satinato white
 Order no: D0002

AT 540 AT 530 AT 520 AT 510 AT 500 HT 410 HT 400



DA

Colour: HDS08

Handle: HS40

Glass: Satinato white

Order no: D0001

AT 540 AT 530 AT 520 AT 510 AT 500 **HT 410** HT 400

SERIES.G

CONCISE & CLEAR

With the third series in this range, the emphasis is very clearly on the glass elements. Depending on model and personal preference, milled grooves and decorative trims can be added.





GJ

Colour: Frame HF735
Sash: HF735, HF716
Handle: SG13
Glass: Satinato white
Decorative strip: Alunox 80mm
Order no: G0004

AT 540 **AT 530** AT 520 AT 500 HT 410 HT 400



GA

Colour: HM716
 Handle: HS42
 Glass: Satinato white
 Order no: G0001

AT 540 AT 530 AT 520 AT 510 AT 500 HT 410 HT 400



GD

Colour: HFM05
 Handle: KGS04
 Glass: Satinato white
 Decorative strip: Alunox 80mm
 Order no: G0002

AT 540 AT 530 AT 520 AT 510 AT 500 HT 410 HT 400

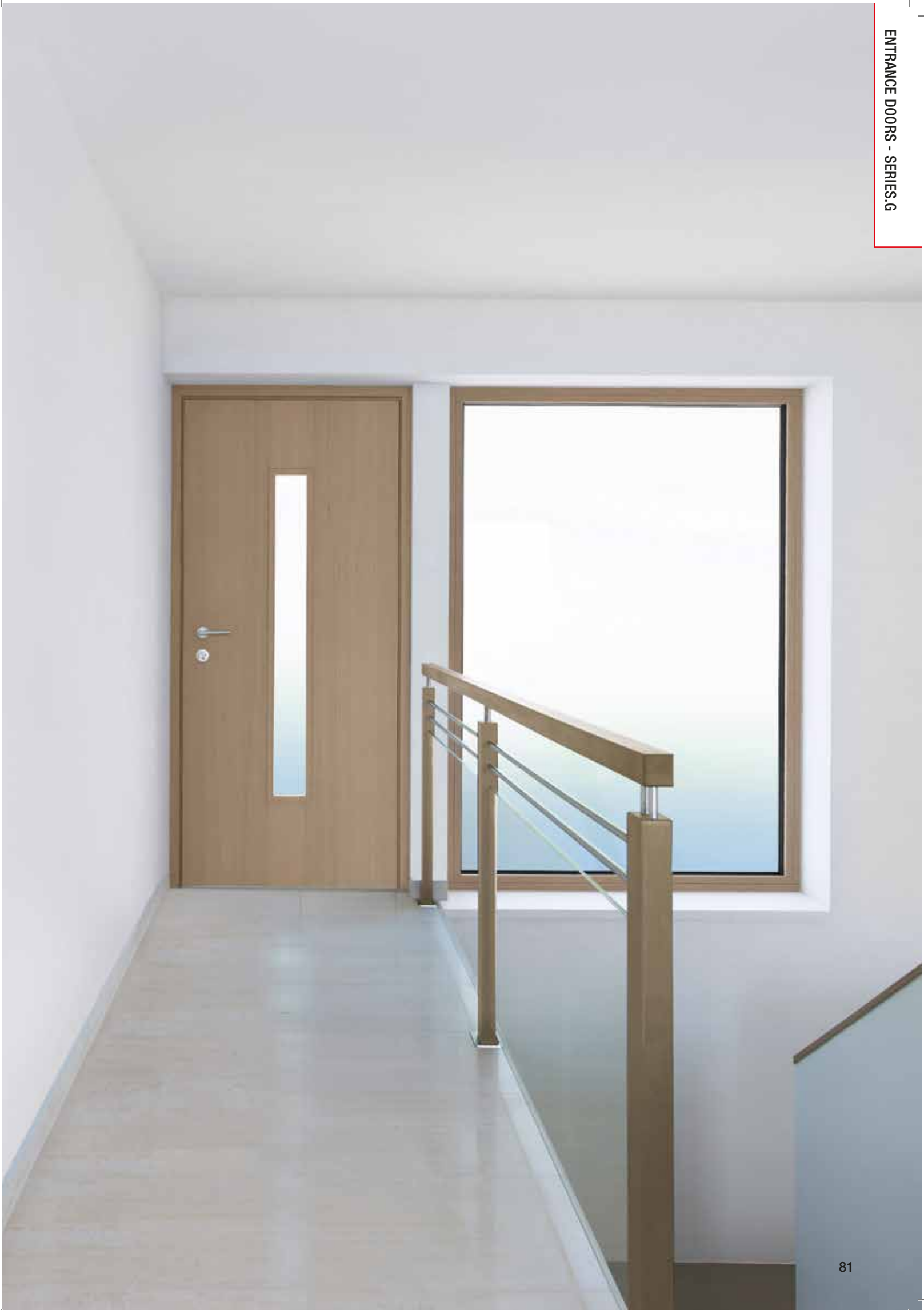



Design your own entrance door with our clever Door Designer tool. Upload a picture of the front of your house and create your bespoke door.



TRANSOM DESIGN

Colour: HM716
Handle: HS50
Glass: Satinato white
Bars: 97mm
Order no: X0002

AT 500



GEORGIAN BAR DESIGN

Colour: HM722
Handle: HS30
Glass: Satinato white
Bars: 60mm/40mm
Order no: X0006

AT 500

ENTRANCE DOORS

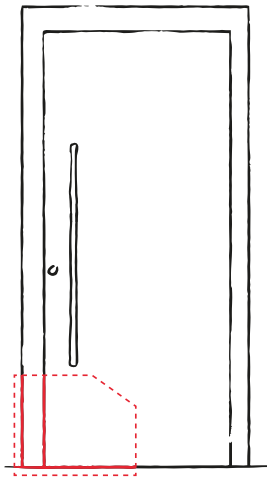

AT 540







AT 530

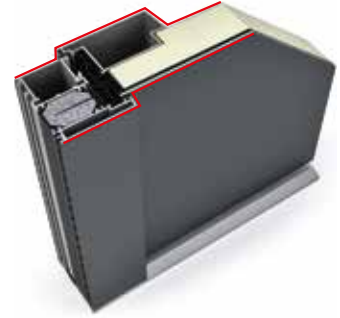

AT 520



Material	Aluminium	Aluminium	Aluminium
Design	Flush inside and outside	Square edge on inside and outside	Round edge on inside, square edge on outside
Thermal insulation in $W/(m^2K)$	 U_D up to 0.78	U_D up to 0.75	U_D up to 0.81
Noise reduction in dB	 up to 35	up to 34	up to 32
Security	 up to RC2	up to RC2	up to RC2
Locking	 Multi-point locking	Multi-point locking	Multi-point locking
Construction Depth in mm	 93	93	93
Gasket	3	3	3
Threshold	Thermally broken	Thermally broken	Thermally broken
Insulation	3-chamber frame profile, insulating foam core	3-chamber frame profile, insulating foam core	3-chamber frame profile, insulating foam core

AT 510

AT 500

HT 410

HT 400



Aluminium	Aluminium	Timber-Aluminium	Timber-Aluminium
Round edge on inside, square edge on outside	Round edge on inside and outside	Flush inside and outside	Square edge on inside and outside
U _b up to 0.98	U _b up to 0.91	U _b up to 0.58	U _b up to 0.73
up to 38	up to 40	up to 34	up to 34
up to RC2	up to RC3	up to RC2	up to RC2
Multi-point locking	Multi-point locking	Multi-point locking	Multi-point locking
93	93	121	85
3	3	3	3
Thermally broken	Thermally broken	Thermally broken	Thermally broken
3-chamber frame profile, insulating foam core	3-chamber frame profile, insulating foam core	Thermal foam insulation	Thermal foam insulation

DOOR HANDLES

RECESSED HANDLES

Both attached and flush possible. Only attached version possible with the AT500 and AT520.



SG16
Recessed handle, 430x100
Stainless steel
AT500, AT520, AT530, AT540, HT400, HT410



SG13
Recessed handle, 220x125
Stainless steel
AT500, AT520, AT530, AT540,
HT400, HT410



SG17
Recessed handle,
110x500
Stainless steel, black
AT500, AT520, AT530,
AT540, HT400, HT410

LED lighting optional
with AT530 and AT540



SG18
Recessed handle,
110x1400
Stainless steel
AT500, AT520, AT530,
AT540, HT400, HT410

LED lighting optional-
with AT530 and AT540

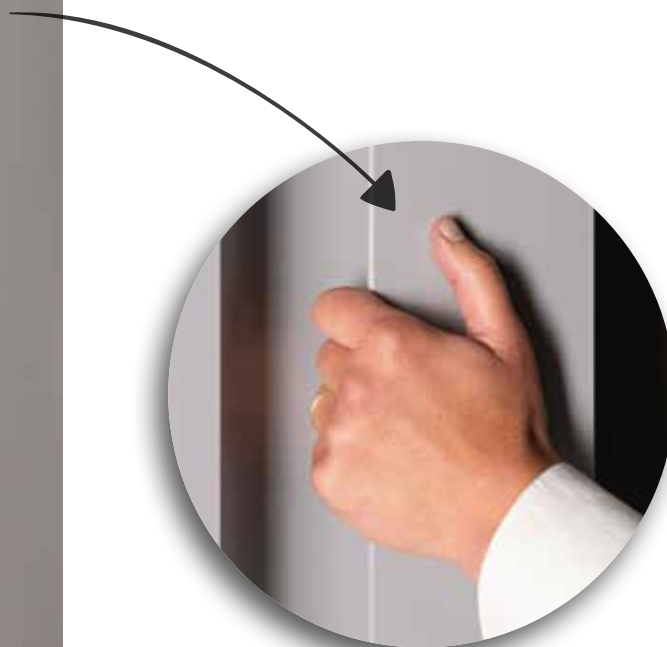

GSIV
Integrated recessed handle

GS140
406x59

GS101
1000x59

GS102
1200x59

GS103
1400x59

GSIV
Length variable

in the corresponding colour of
the door sash, black
AT500, AT520, AT530,
AT540, HT400, HT410

LED lighting optional

BAR HANDLES

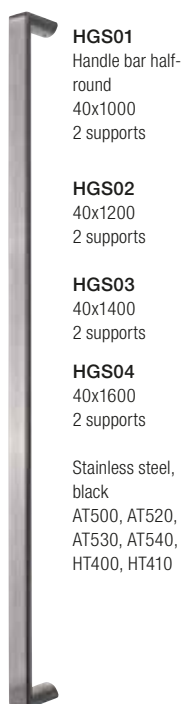

HGS01
Handle bar half-round
40x1000
2 supports

HGS02
40x1200
2 supports

HGS03
40x1400
2 supports

HGS04
40x1600
2 supports

Stainless steel, black
AT500, AT520, AT530, AT540, HT400, HT410



KGS01A
for ekey-dLine
Square handle bar
40x1000
2 supports

KGS05A
for ekey-dLine
Square handle bar
40x1800
3 supports

Stainless steel
AT530, AT540, HT400, HT410



KGS01
Square handle bar
40x1000
2 supports

KGS02
40x1200
2 supports

KGS03
40x1400
2 supports

KGS04
40x1600
3 supports

KGS05
40x1800
3 supports

KGS06
40x2000
3 supports

Stainless steel, black
AT500, AT510, AT520, AT530, AT540, HT400, HT410

KGS01L
(without ill.)
40x1000
2 supports with integrated LED lighting

KGS03L
(without ill.)
40x1400
2 supports with integrated LED lighting

Stainless steel
AT530, AT540, HT400, HT410



RGS01
Round handle bar
Ø 30
Height 1000
2 Supports

RGS02
Height 1200
2 Supports

RGS03
Height 1400
2 Supports

RGS04
Height 1600
3 Supports

RGS05
Height 1800
3 Supports

RGS06
Height 2000
3 Supports

Stainless steel
AT500, AT510, AT520, AT530, AT540, HT400, HT410



EGS01
Round handle bar
Ø 35
Height variable

Stainless steel
AT500, AT510, AT520, AT530, AT540, HT400, HT410



GKV01
Square handle bars with straight ends
30x1000

GKV02
30x1200

GKV03
30x1400

GKV04
30x1600

Stainless steel, black
AT500, AT520, AT530, AT540, HT400, HT410



RSS01
Round Handle bars with angled supports
Ø 32
Height 1000
2 Supports

RSS02
Height 1200
2 Supports

RSS03
Height 1400
2 Supports

RSS04
Height 1600
3 Supports

RSS05
Height 1800
3 Supports

RSS06
Height 2000
3 Supports

Stainless steel
AT500



GOK60
Handle bar
Height 600
2 Supports
Stainless steel
AT500, AT520, AT530, AT540, HT400, HT410



GKV60
Handle bar
Height 600
2 Supports
Stainless steel, black
AT500, AT520, AT530, AT540, HT400, HT410



GPR60
Handle bar
Height 600
2 Supports
Stainless steel
AT500, AT520, AT530*, AT540*, HT400*, HT410*

GPR60A
for ekey dLine
Height 600
2 Supports

GPR60L
with integrated LED lighting
Height 600
2 Supports

A stylish selection of handles is available for all door series.

Please note that not all handles are available on all doors.

The pictured handles are not in proportion and this page only shows a selection of handles available.

Dimensions are in mm, width x height.

PUSH AND BRACKET HANDLES



HS10
Push handle
93x400
Stainless steel
AT500, AT510, AT520,
AT530, AT540,
HT400, HT410

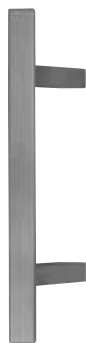

HS50
Push handle
109x500
Stainless steel
AT500, AT510, AT520,
AT530, AT540,
HT400, HT410



HS40
Push handle
90x500
Stainless steel matt
AT500, AT510, AT520,
AT530, AT540,
HT400, HT410



HS42
Push handle
90x500
Stainless steel
AT500, AT510, AT520,
AT530, AT540,
HT400, HT410



PB30
Tubular U-handle
100x300
Stainless steel
(PB31 = AluF1)
AT500



HS32
Push handle
118x477
Stainless steel
(HS30 = ring
Stainless steel matt)
AT500, AT510, AT520,
AT530, AT540,
HT400, HT410



GKN201
Stainless steel
AT500

LEVER



GD25
Stainless steel, black
AT500, AT510, AT520,
AT530, AT540, HT400, HT410



PD12
Aluminium brushed
AT510, AT520,
AT530, AT540



GD10
Stainless steel
AT500, AT510, AT520, AT530,
AT540, HT400, HT410



GD15
Stainless steel, black
AT500, AT510, AT520, AT530,
AT540, HT400, HT410



GD20
Stainless steel
AT500, AT510, AT520, AT530,
AT540, HT400, HT410



GD30
Stainless steel
AT500, AT510, AT520,
AT530, AT540, HT400,
HT410



SD10
Stainless steel, black
AT510, AT520, AT530, AT540,
HT400, HT410



SD15
Stainless steel
(SD20 = Alu Natural, SD25 = Alu white)
AT500, AT510, AT520, AT530

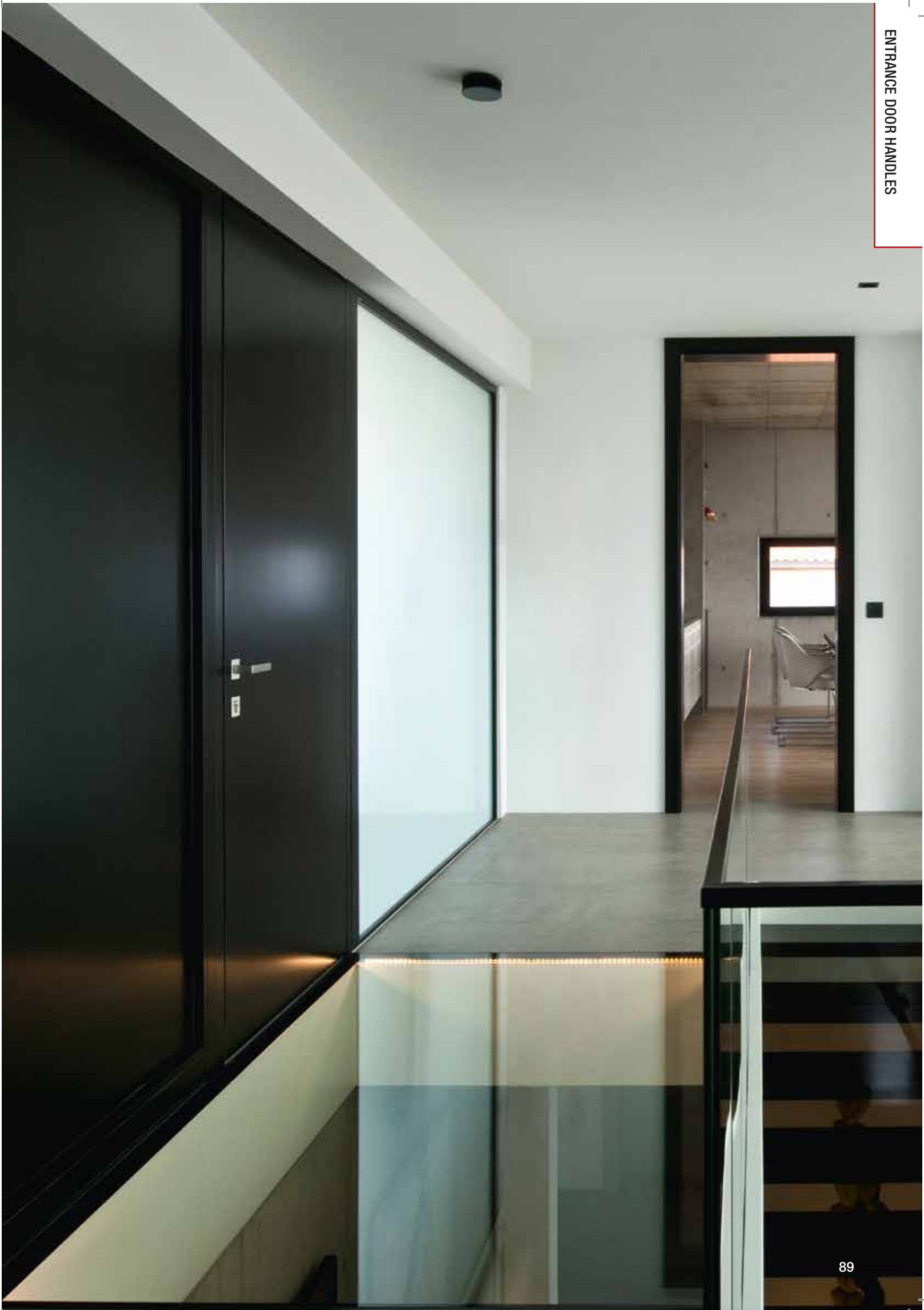

COLOURS

Please note that not every colour is available for every door, frame or door sash.

Due to printing and manufacturing technology, colour and surface deviations between illustration and original products may occur.

Your **Internorm partner** will be happy to show you original colour samples.

* **Highly weather resistant**, except M916 (facade quality).

** Intensive colour appearance, variation possible.

*** For surface options **HM** (highly weather-resistant standard colour), **HF** (highly weather-resistant fine structure), **HFM** (highly weather-resistant fine structure metallic), a special highly weather-resistant powder coating is used.

EXTERNAL AND INTERNAL COLOURS

STANDARD COLOURS*



HDS COLOURS**



hirest-COLOURS***



STAINLESS STEEL COLOURS

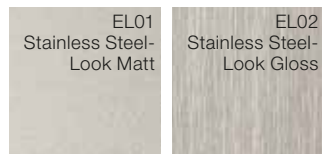

Please note

The Internorm RAL colour range (facade quality) offers even more design options.

EXTERNAL COLOURS

SD COLOURS

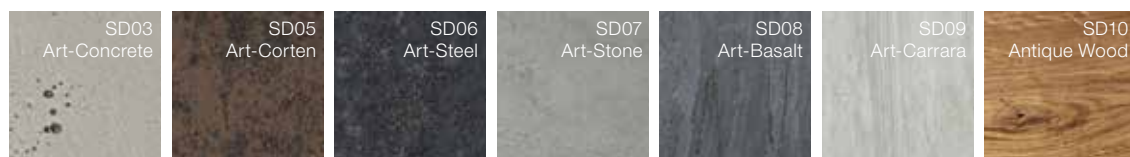

INTERNAL COLOURS

TIMBER STANDARD COLOURS

SPRUCE

varnished



SPRUCE

opaque



ASH

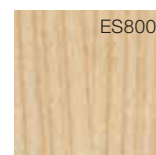

WALNUT

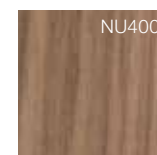

OAK



LARCH varnished



YOUR FINGER IS THE KEY

No more tedious searching for keys, thanks to fingerprint scanners or keypads. At Internorm, these intelligent systems are attached to or integrated flush into the door sash or handle.

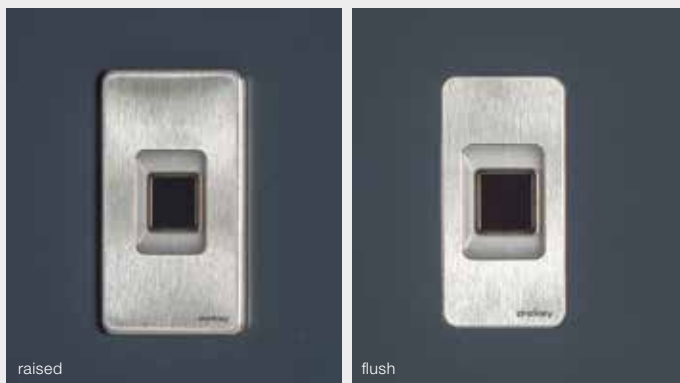

FINGERPRINT SCANNER

The integrated, new generation 'ekey-dLine' fingerprint scanner conveniently replaces conventional keys. The control unit is space-saving and securely housed in the door sash or handle. Keys, cards, or codes are no longer forgotten, lost or stolen.

Simple. You open the door with just your finger via the ekey-bionyx App. There is no need for a technician – you are in control. The intelligent software learns with every use and recognises children's growing fingers or changes in user habits.

Secure. Your unique fingerprint is more secure than a key, which can be lost or stolen. Manipulation of the system from the outside and unauthorised use is made impossible.

'Smart' entrance door. The system can be integrated into your Smart Home system via Wifi and therefore offers countless features, including remote opening or push notifications when door is being opened. Even a quick 'Alexa, open the door' will activate it if you are tied up. The programming and management of the fingerprint scanner is via smartphone or tablet. The Bluetooth connection is secured by a 6-digit coupling code. Suitable for Apple and Android mobile phones or tablets.

KEYPAD

A more traditional option for securely entering your home is a keypad. The slim and smart ekey home integra keypad is installed directly into the door sash or in the wall next to the door. The system is compatible with all E-openers and motorised locks. A cable transports the encrypted opening signal to an electronic relay. The relay sends the opening impulse to the motor lock. The system cannot be manipulated from the outside.

The lock is opened by your individual four to ten-digit code. The touch-sensitive pad can even remember a pattern just like on a mobile phone.

Up to 99 codes can be programmed and each user will have their own access code. You can manage and limit the access of individuals to certain times or days, for example cleaners.

Additional security features, such as the Winkhaus high security cylinder, door restrictor, electric door opening/ETOE and chrome spy hole are available on request from your Internorm partner.



SIDE ENTRANCE DOORS

Side entrance doors serve to close off unused, unheated rooms (e.g. garage, basement storage rooms). Current statistics show that intruders predominantly gain access to a house via side and back entrances. It is therefore all the more important to consider relevant security features – Internorm offers different security systems upon request.

Side entrance doors are available in timber-aluminium, aluminium and uPVC and offer a wide range of individual design options.

TIMBER-ALUMINIUM



HF 410



HF 410

ALUMINIUM



AT 500 panel model
Colour: HM704, handle: HS10
Order no.: X0008



AT 500 Glass model
Colour: Frame M916, handle: HS10
Glass: Satinato white
Order no.: X0009





uPVC



AT 500 Glass panel model
 Colour: HM716, handle: HS10
 Glass: Satinato white
 Order no.: X0010



KF 410



AT 500 Glass panel model
 Colour: HM735, handle: HS10
 Glass: Satinato white
 Order no.: X0011



KF 310



KF 310

WARRANTIES

OUR WARRANTIES ENSURE THAT YOU CAN ENJOY YOUR INTERNORM PRODUCTS FOR MANY YEARS TO COME.

As the leading European, internationally active, window brand with 91 years of experience, Internorm is focused on developing innovative, exceptionally high quality and reliable window and door solutions. That's our guarantee.

Warranty

15
YEARS

- Against condensation between the sealed panes of insulating glass, if the glass is not heavier than 80kg.

Warranty

10
YEARS

- On weather resistance against unnatural change of colour and cracks in surfaces of:
 - white uPVC window and door profiles, except for mitre cracks.
 - inside foil covered uPVC window and door profiles, except for mitre cracks.
 - anodised (a form of metal coating) or powder coated aluminium window and door profiles.
- Against condensation between the sealed panes of insulating glass.
- On the glue connection of glued Georgian/feature bars.
- On the function of the material compound timber, thermal foam and aluminium profiles in timber aluminium composite products when adhering to the Internorm fitting and maintenance guidelines.
- On the function of the glued connection and sealing of the insulating glass panes with window profiles in timber aluminium composite products when adhering to the Internorm fitting and maintenance guidelines.
- Where goods are supplied with marine grade aluminium finish.

Warranty

5
YEARS

- For PVD coated entrance door handles against corrosion, if no mechanical damage is apparent.
- On weather resistance against unnatural colour changes or cracks in door filling surfaces.

Warranty

3
YEARS

- On weather resistance against unnatural change of colour and cracks in surfaces of anodised or powder coated aluminium roller shutters, blinds and window shutter profiles.
- On the function of window and door hardware when the Internorm fitting and maintenance guidelines have been followed.
- On weather resistance against unnatural change of colour and cracks in surfaces of uPVC roller shutter profiles.

Product
Availability
Warranty

30
YEARS

Internorm guarantees that our Goods manufactured from 1999 onwards are capable of being repaired by our specialists in such a way that their full functionality is guaranteed to subsist or be retained over a time period of 30 years. However, this is subject to the construction (i.e. frames and sashes) remaining undamaged and subject to the customer paying our costs of repair, where applicable. The 30-year period begins with the Internorm production date, confirmation of which will be provided on request. The services or materials, labour time etc., necessary to retain functionality will be charged at respective current rates.

WARRANTIES/EXTRACT:

The full version of our warranty information, warranty requirements and how to make a warranty claim, can be found in the Internorm Maintenance, Care and Warranties Manual. This Manual is delivered together with your Internorm products. It is additionally available as a PDF from the Download section of our website, and available from every **Internorm distribution partner**.

NATIONAL AND INTERNATIONAL CERTIFICATIONS CONFIRM THE HIGH QUALITY OF OUR PRODUCTS.

Internorm's wealth of experience and focus on innovative technical solutions ensure that you receive the best product and service. High-tech production facilities and the strictest quality controls ensure that the our product quality sets industry standards. Prestigious awards and certifications from leading European test institutes confirm this.



Austrian State Emblem



Austrian Quality Label



TÜV



Institute for Window Technology
Rosenheim



RAL Quality Seals



Technical University Graz



QUALITÄTS
FENSTER
MADE IN AUSTRIA



Minergie® Certificate



Austrian Society for
Environment Simulation



Certificate for products from
sustainable forestry

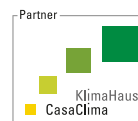

KlimaHaus Certificate



Climate Association
Town Traun



Energy Globe
(Project Schiesthaus)



VinylPlus Certificate



EnergieGenie 2016
(HF 410)



EnergieGenie 2020
(KF 520)



GERMAN
DESIGN
AWARD
WINNER
2021



GERMAN
INNOVATION
AWARD '20
WINNER



IMPRINT

Publisher: Internorm International GmbH, Ganglgutstraße 131, A-4050 Traun

Photos: Studio Hoflehner, A-4600 Wels | studio46, A-4863 Seewalchen am Attersee | Isa Stein, Studio für Kunst und Architektur, A-4020 Linz | Bernhard Hörtnagl, A-6020 Innsbruck | Internorm International GmbH, A-4050 Traun

Design and Litho: Internorm International GmbH, A-4050 Traun

Print: Hague Group, Leicester, LE19 4SD, UK

Subject to technical changes, layout and printing errors.

Internorm International GmbH is an ARA licence partner: Our licence number is 4477.

HOME IS NOT A
PLACE, IT'S
a feeling.





Andreas Simmer
UK Managing Director

- Internorm manufacturing sites (production exclusively in Austria)
- Internorm offices
- Internorm distribution partners

AN ESTABLISHED INTERNATIONAL FAMILY BUSINESS

EUROPE'S NO. 1 WINDOW BRAND

Thank you for your interest in Internorm products. Internorm has been a family business for 91 years, having developed from a one-man blacksmith's shop to the largest internationally active window brand.

During this time we have manufactured over 27 million window and door units, all 100% made in our production facilities in Traun, Sarleinsbach and Lannach in Austria. From the creation of the uPVC window and the production of the timber-aluminium window to today's high-tech and ultra-modern design innovations, our family company has been setting standards across Europe. We are pioneers in our field and continue to further develop technology and innovative ideas.

Our 1974-strong European work force are specialists, who thrive on attention to detail and act with passion and integrity. Together with more than 1300 distribution partners in 21 countries we guarantee product quality and the highest levels of service.

Internorm®

Internorm Windows UK Ltd

Unit D · Colindale Business Park
2-10 Carlisle Road · London, NW9 0HN
Tel.: +44 (0) 208 205 9991
Email: office@internorm.co.uk

uk.internorm.com
commercial.internorm.com



UK brochure

03/2022