



Bi-folding doors



Highline bi-folding door system



Focus

“In a society that celebrates the immaterial, architecture can offer a source of resistance, fighting against the erosion of form and meaning and speaking its own language.” Peter Zumthor, Architect



Contents

Bi-folding doors from Solarlux	8
Application areas	14
Opening options	18
Materials and surfaces	22
Versatility with bi-folding doors	32
Technical features	34
Ecoline and Highline	36
Megaline	40
SL 35 and SL 45	44
Woodline	48
Combine	52
SL 97	56
System comparison	60
Windows for the bi-folding door family	62
Accessories for bi-folding doors	68
Technology	74
A sustainable, family-run company	92
Solarlux digital	98

Bi-folding doors from Solarlux

Outdoors is the new indoors

Being outside - or, even better - being able to cultivate your outdoor life in line with your own individual expectations is, for many people, the purest joy imaginable. It can improve their well-being, help them relax, and provide them with the perfect atmosphere to thrive. Being close to nature helps us feel grounded in our lives, transforming the outdoors into an extension of our man-made living spaces. It can even act as a daring alternative to the traditional concept of having your "own four walls" - emotional benefits

guaranteed. When we make a bi-folding door at Solarlux, we also create something much more valuable, something special - a literal sensation of openness that will soon become part of your "everyday" life. Ask yourself this: how many walls do you really need around you? One thing's for sure - we've got the answers. Read on, and let us inspire you.

Open living

For around 40 years, Solarlux has stood for the outstanding quality of versatile glazing solutions for public and private spaces. The bi-folding door has been the beating heart of the international, family-owned company right from the very beginning. Unlike traditional sliding doors, all the individual elements of a bi-folding door can be gathered up in a slender bundle of panels at one side. This produces generous glass fronts that can be opened across almost 100 % of their width while still offering maximum protection when closed. Its functionality, the creative freedom offered by its high-quality materials, and the limitless possibilities for combining it with other elements make the bi-folding door the ideal solution for a wide range of projects. Whether used as a passive house element that offers high levels of thermal insulation or as a non-insulated variant in a pergola - in terms of both its flexibility and the space it opens up, the bi-folding door knows almost no boundaries.





Ref. 327* // Ecoline

Photo: Simon Menges

Facts that speak for themselves

In addition to their emotional value, bi-folding doors also offer tangible, quantifiable benefits. Security, accessibility, energy-efficiency, sound insulation - these advantages speak for themselves.

What Solarlux offers

- + In-depth consultation and planning
- + Patented technical details
- + Durability and high quality
- + High German production standards
- + Certified by national and international institutes
- + Maximum transparency and flexibility
- + Filigree sight lines from 99mm
- + Sophisticated technical design and installation
- + Compliance with all applicable standards and specifications



Accessibility and convenience

Bi-folding doors are extremely convenient, with accessible floor tracks available for living spaces with durable stainless steel carriages and rollers.



Slender sight lines

The most important feature of the bi-folding door is its accordion-like folding principle, which allows it to be opened across almost 100% of its width. When closed, it boasts incredibly slim sight lines of from just 99 mm across the panel butt joint.



Security and anti-burglary protection

Bi-folding doors are high-quality and extremely sturdy. They fulfil the requirements of the standard European anti-burglary protection class RC2. This even applies to systems with an even number of panels - which is a benefit you won't find anywhere else on the market.



Thermal and sound insulation

A bi-folding door guarantees optimum thermal insulation and, depending on the system and packages, can also be used for passive houses. The sound reduction index that can be achieved with these elements guarantees a quiet living space, even in bustling, built-up areas.

For rooms
without limits

Application areas

Suitable for a wide range of applications

The possibilities offered by a bi-folding door are almost limitless. It can be used as an element for a wintergarden glazed extension that can be opened across almost its entire width, employed as an alternative to a traditional patio door or window, or used as an entrance to a pool. And it's also suitable for public spaces, of course! Use it to build your shop entrance, glaze the VIP box in your stadium, or create a facade on your balustrade. In addition to bi-folding doors, you can also create entire facades using windows, top lights, fixed elements and sliding doors. And of course, all these solutions are available with harmonised profile sight lines, glass positions, material properties and surfaces - all in Solarlux quality.







SDL Avantgarde wintergarden with Highline bi-folding door



Ref. 1356* // SDL Akzent plus; Ecoline modular



Ref. 157* // SL 70e

Opening options

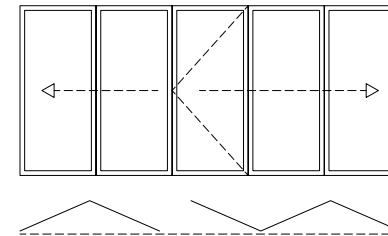
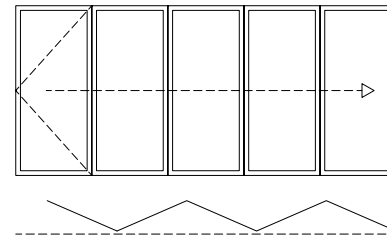
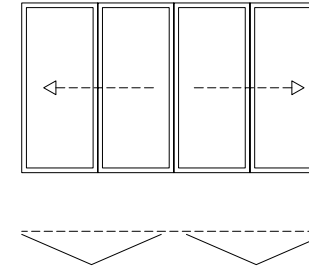
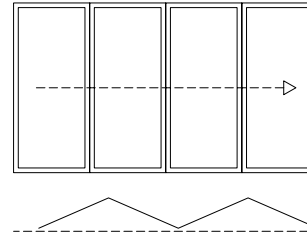

The opening options

Inwards or outwards, folding to the left and/or to the right - Solarlux bi-folding doors offer countless opening system possibilities. Thanks to the wide range of options available - including installation on a balustrade or with a segmented ground plan, for example - the systems are suited to use in a huge variety of projects. The individual glass elements can be opened or closed in just a few simple steps, across their whole area.

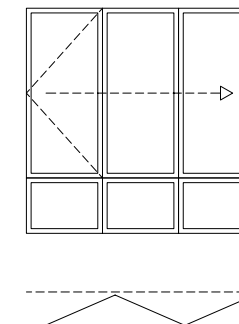
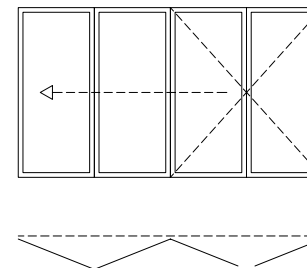

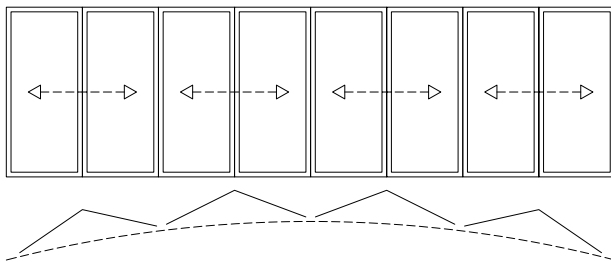
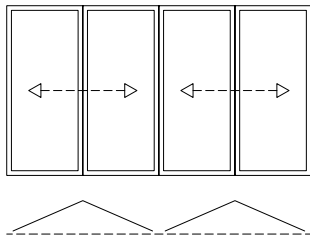
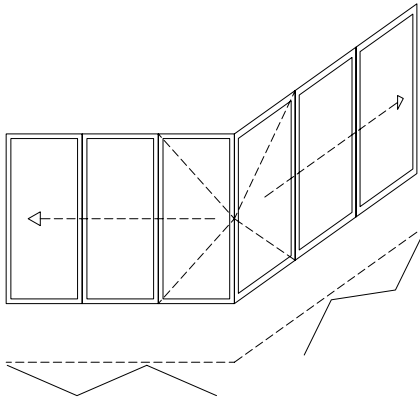

An unparalleled range of combination options!
Bi-folding doors can be combined with many other elements, such as tilt-and-turn panels, fixed elements and sliding doors. Since all our systems use the same profiles, a homogenous appearance and extensive connection options are guaranteed.



Ref. 575* // Woodline

© Studio PROTOTYPE



Ref. 575* // Woodline

**WOULD YOU LIKE TO RECEIVE
THE COMPLETE FULL VERSION FREE
BY POST OR EMAIL?**

**CLICK HERE
TO ORDER**

